

1.14010.60	T	16	1.14013.60	T	20
1.14011.60	T	20	1.14017.60	T	16
1.14012.60	T	16	1.14018.60	T	20

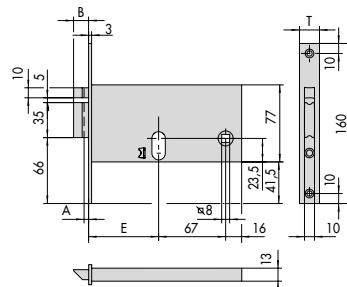

1.14450.70	E	70	T	16	B	10,5	A	.
1.14450.80	E	80	T	16	B	10,5	A	.
1.14450.90	E	90	T	16	B	10,5	A	.
1.14451.70	E	70	T	20	B	10,5	A	.
1.14451.80	E	80	T	20	B	10,5	A	.
1.14451.90	E	90	T	20	B	10,5	A	.
1.14452.70	E	70	T	14,7	B	15	A	4,5
1.14452.80	E	80	T	14,7	B	15	A	4,5
1.14452.90	E	90	T	14,7	B	15	A	4,5

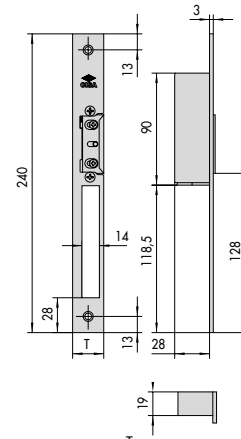

1.15020.00	T	25
1.15021.00	T	34
1.15030.00	T	25

1

4

7

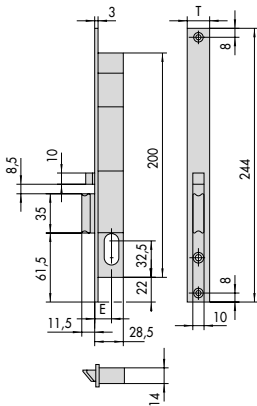

1.14020.15	T	16	F	15	1.14021.15	T	20	F	15
1.14020.18	T	16	F	18	1.14021.18	T	20	F	18

2

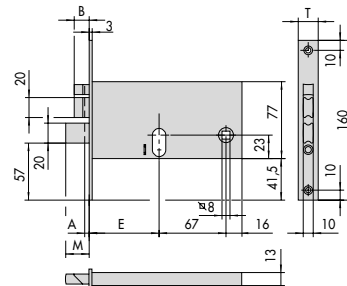

1.14460.70	E	70	T	16	B	10,5	A	.
1.14460.80	E	80	T	16	B	10,5	A	.
1.14460.90	E	90	T	16	B	10,5	A	.
1.14461.70	E	70	T	20	B	10,5	A	.
1.14461.80	E	80	T	20	B	10,5	A	.
1.14461.90	E	90	T	20	B	10,5	A	.
1.14462.70	E	70	T	14,7	B	15	A	4,5
1.14462.80	E	80	T	14,7	B	15	A	4,5
1.14462.90	E	90	T	14,7	B	15	A	4,5

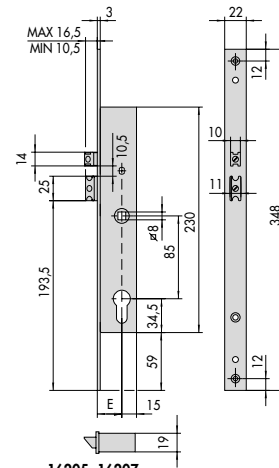

16205, 16207

E = 25 - 30 - 35

5

8

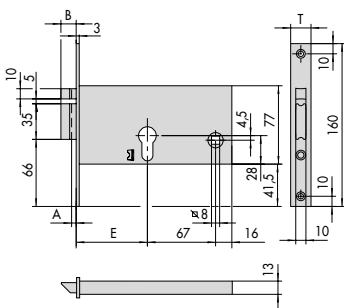

1.14350.70	E	70	T	16	B	10,5	A	.
1.14350.80	E	80	T	16	B	10,5	A	.
1.14350.90	E	90	T	16	B	10,5	A	.
1.14351.70	E	70	T	20	B	10,5	A	.
1.14351.80	E	80	T	20	B	10,5	A	.
1.14351.90	E	90	T	20	B	10,5	A	.
1.14352.70	E	70	T	14,7	B	15	A	4,5
1.14352.80	E	80	T	14,7	B	15	A	4,5

3

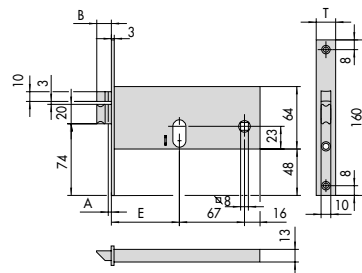

1.14510.70	E	70	T	16	B	10,5	A	.
1.14510.80	E	80	T	16	B	10,5	A	.
1.14510.90	E	90	T	16	B	10,5	A	.
1.14511.70	E	70	T	20	B	10,5	A	.
1.14511.80	E	80	T	20	B	10,5	A	.
1.14511.90	E	90	T	20	B	10,5	A	.
1.14512.70	E	70	T	14,7	B	15	A	4,5
1.14512.80	E	80	T	14,7	B	15	A	4,5
1.14512.90	E	90	T	14,7	B	15	A	4,5

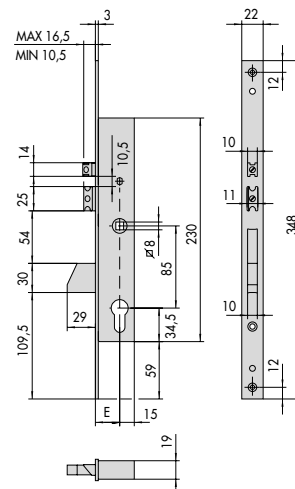

16215, 16217

E = 25 - 30 - 35

6

9