

# Panasonic®

## Operating Instructions

### Network Camera

Model No. **BB-HCM381A**

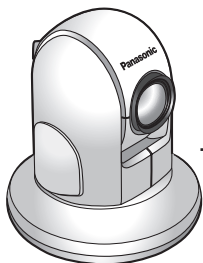

Please read this manual before using and save this manual for future reference.

Panasonic Network Camera Website: <http://www.panasonic.com/netcam>

for customers in the USA or Puerto Rico

# Main Features

## IPv6<sup>1</sup> Network Camera

Your Panasonic Network Camera supports IPv6 (Internet Protocol Version 6), IPv6 was created to address the additional IP addresses that will be needed as the Internet continues to expand. Since the camera also supports IPv4 that's currently used, it is "dual stack" design will seamlessly operate while IPv6 is phased in. For more information in IPv6 you wish to visit <http://www.ipv6.org/>. See page 15 for more information.

## Audio 2-way Communication<sup>2</sup> (Walkie-talkie Type)

2-way audio communication is now possible between your Network Camera and PC. By connecting a user-supplied microphone and speaker<sup>3</sup> to both the camera and to the PC, you will be able to speak to and hear anyone within range of the camera.

For example, the camera can be used in the following various locations:

- In the baby's room, to hear if the baby is crying.
- At the front door, to see and hear who is at the door.
- In the children's play room, to see and hear if they are safe.

### Note

PLEASE NOTE that under certain circumstances, audio/video recording may be PROHIBITED by law. This device should be used only in compliance with all applicable federal, state and local statutes.

## Better Image Quality

The CCD sensor and the color night view mode provides better image quality and low light performance.

- The CCD sensor gives you clear image.
- You can monitor live video (Motion JPEG) that refreshes its image 30 frames per second.
- Color night view mode allows you to monitor the camera in low illuminance.

---

<sup>1</sup> To connect in IPv6, subscribe to the ISP's "IPv4/IPv6 Dual-Stack" or "IPv6 over IPv4 Tunneling" service. The camera does not work in IPv6-only network.

<sup>2</sup> Audio feature does not work well on cell phones. Talk button and Listen button cannot be used simultaneously. In consequence of traffic and network environments, the audio may be delayed or may break up.

<sup>3</sup> The speaker connected to the camera requires a built-in amplifier.

## Remote Pan/Tilt/Zoom/Focus

The following features allow you to operate Network Camera from web browser on your PC. High speed Pan/Tilt operation can move the lens horizontally from  $-175^{\circ}$  to  $+175^{\circ}$  and vertically from  $-120^{\circ}$  to  $0^{\circ}$  in mounting on the table and from  $0^{\circ}$  to  $+90^{\circ}$  in mounting on the ceiling. This movable lens allows you to view a wide range of perspective from a distant place. Network Camera has a 42x magnifying capacity: a 21x optical zoom and a 2x digital zoom. Automatic and Manual Focusing features provide you with detailed and distinct images. Additionally, the following control features are available to easily and quickly monitor the camera.

- Click to Center** ..... When you click a certain point on the camera image, the point is centered on the image.
- Preset Position** ..... You can register 8 preset positions. When you click each button, the image switches to its position.
- Output Control** ..... You can control the external devices (Open or Short to GND) (E.g., turning the light on or ringing a buzzer).

## Video Output

Network Camera has an analog composite output terminal. You can view images from Network Camera on TV and record them on videotapes.

## SD Memory Card<sup>1</sup> Recording

The camera has an SD memory card slot. You can record camera images to the SD memory card. If you enable alarm buffer/transfer, you can record the image at the timing of signal detection of door sensor or light. About 58,000 images (320 x 240 resolution and standard quality) can be recorded to 1 GB SD memory card. If you enable 1-minute interval timer buffer/transfer, you can record the images for about 41 days.

## Enhanced Multi-Camera Page

Multi-Camera page displays up to 4 cameras while supporting each audio 2-way communication. The previous model displays only 4 cameras, but this camera can switch 3 sets of 4 cameras. Additionally, the camera can displays maximum 12 cameras on a page in a static image.

## Supporting Viewnetcam.com service

Viewnetcam.com service allows you to access the camera over the Internet with your favorite domain name (e.g. bob.viewnetcam.com) instead of a global IP address.

---

<sup>1</sup> SD memory card is sold separately. The camera supports 1 GB, 512 MB, 256 MB, 128 MB or 64 MB Panasonic SD memory card.

## **Multi-Language Display**

Top page, Single Camera and Multi-Camera page can be displayed in English, French, German, Italian, Spanish, Russian, Simplified Chinese or Japanese. The Setup, Maintenance and Support pages are displayed only in English or Japanese.

## How to Use This Documentation

The camera includes the following 2 manual types.

- **Installation/Troubleshooting**

Installation/Troubleshooting provides explanations for accessories included with the camera, the initial configuration, and troubleshooting tips. The Installation/Troubleshooting helps you to easily configure the camera.

- **Operating Instructions (This manual)**

Operating Instructions explains about operations, settings, features and the cleaning method when using the camera.

## Abbreviations

- UPnP is the abbreviation for Universal Plug and Play.
- "Network Camera" is called "Camera" in this Operating Instructions.

## Trademarks

- Adobe, Acrobat and Reader are either registered trademarks or trademarks of Adobe Systems Incorporated in the United States and/or other countries.
- Microsoft, Windows, Hotmail and ActiveX are either registered trademarks or trademarks of Microsoft Corporation in the United States and/or other countries.
- Pentium is a trademark or registered trademark of Intel Corporation or its subsidiaries in the United States and other countries.
- SD mark is a trademark of the SD Card Association.
- Screen shots reprinted with permission from Microsoft Corporation.
- All other trademarks identified herein are the property of their respective owners.

## System Requirements for your PC

Your PC (Personal Computer) and network must meet the following technical specifications for the camera to work properly.

### For IPv4 Connection

Item	Description
<b>Operating System</b>	Microsoft® Windows® XP, Microsoft® Windows® 2000 Microsoft® Windows® Me, Microsoft® Windows® 98SE
<b>CPU</b>	<ul style="list-style-type: none"> <li>• <b>For viewing single camera</b> Pentium® III (800 MHz or greater is recommended.)</li> <li>• <b>For viewing multiple cameras</b> Pentium 4 (1.8 GHz or greater is recommended.)</li> </ul>
<b>Protocol</b>	TCP/IP protocol (HTTP, TCP, UDP, IP, DNS, ARP, ICMP)
<b>Interface</b>	10/100 Mbps network card installed
<b>Web Browser</b>	Internet Explorer 6.0 or later (Not included on the Setup CD-ROM)
<b>Audio</b>	Audio input/output feature (Microphone or speaker)

**For IPv6 Connection**

Item	Description
<b>Operating System</b>	Microsoft® Windows® XP Service Pack 1 or later
<b>CPU</b>	<ul style="list-style-type: none"> <li>• <b>For viewing single camera</b> Pentium III (800 MHz or greater is recommended.)</li> <li>• <b>For viewing multiple cameras</b> Pentium 4 (1.8 GHz or greater is recommended.)</li> </ul>
<b>Protocol</b>	TCP/IP protocol (HTTP, TCP, UDP, IP, DNS, ICMPv6, NDP)
<b>Interface</b>	10/100 Mbps network card installed
<b>Web Browser</b>	Internet Explorer 6.0 or later (Not included on the Setup CD-ROM)
<b>Audio</b>	Audio input/output feature (Microphone or speaker)

**Note**

See Panasonic Network Camera support website at <http://panasonic.co.jp/pcc/products/en/netwcam/> for the latest information about web browser.

## **IMPORTANT SAFETY INSTRUCTIONS**

When using this unit, basic safety precautions should always be followed to reduce the risk of fire, electric shock, or personal injury.

- 1.** Read and understand all instructions.
- 2.** Keep these instructions.
- 3.** Heed all warnings.
- 4.** Follow all instructions.
- 5.** After taking away the sand or the dust on the lens, wipe the lens with lens cleaning paper.
- 6.** Do not block any ventilation openings. Install in accordance with the manufacturer's instructions.
- 7.** Do not install near any heat sources such as radiators, heat registers, stoves, or other devices (including amplifiers) that produce heat.
- 8.** Protect the AC adaptor cord and AC cord from being walked on or pinched particularly at plugs, convenience receptacles, and the point where they exit from the unit.
- 9.** The AC cord is used as the main disconnect device, ensure that the socket-outlet is located/installed near the equipment and is easily accessible.
- 10.** Only use attachments/accessories such as stand specified by the manufacturer.
- 11.** Do not touch the unit or the AC adaptor cord and AC cord during lightning storms.
- 12.** Unplug the unit when unused for long periods of time.
- 13.** Refer all servicing to qualified service personnel. Servicing is required when the unit has been damaged in any way, such as the AC adaptor cord, AC cord or plug is damaged, the unit does not operate normally, or has been dropped.
- 14.** The attached AC adaptor and AC cord is intended for indoor use only. Both AC adaptor and AC cord must be waterproofed for outside use.
- 15.** Keep the SD memory card (customer-provided) out of reach of children to prevent swallowing.

**SAVE THESE INSTRUCTIONS**



### **User Name and Password Protection**

**The use of a unique User Name and secret Password is an important tool that will help limit unauthorized individuals from accessing the camera. If you choose to disable this tool, and choose not to limit access by use of a User Name and Password, this may result in access to the camera by unauthorized individuals. (see page 77)**

# Table of Contents

<b>1</b>	<b>Camera Monitoring .....</b>	<b>13</b>
1.1	Accessing the Camera.....	13
1.1.1	To Access the Camera in IPv6.....	15
1.2	Viewing Single Camera page.....	17
1.2.1	Auto Centering the Image (Click to Center).....	21
1.2.2	Capturing a Still Image .....	22
1.2.3	Using Operation Bar .....	23
1.2.4	Zooming In and Out.....	25
1.2.5	Automatic and Manual Focusing.....	26
1.2.6	Setting Home Position/Alarm Position/Preset Button .....	28
1.3	Listening to Camera Audio—Talking to the Camera .....	32
1.4	Viewing Multi-Camera page .....	34
1.5	Viewing Buffered Image page .....	36
1.5.1	Deleting Buffered Images .....	38
1.6	Viewing Still Images on Your Cell Phone .....	39
<b>2</b>	<b>Various Camera Features .....</b>	<b>41</b>
2.1	Using Camera Features .....	41
2.2	Connecting the Camera to Your IPv4 Network .....	44
2.3	Connecting the Camera to Your IPv6 Network .....	49
2.4	What is IPsec? .....	53
2.5	Encrypt the Camera Image in Transport Mode .....	56
2.6	Encrypt the Camera Image in Tunnel Mode.....	59
2.7	Using UPnP™ (Universal Plug and Play) .....	63
2.8	Registering with the Viewnetcam.com service .....	65
2.9	Setting Date and Time .....	67
2.10	Changing Camera Settings.....	69
2.11	Adjusting Audio .....	75
2.12	Changing Authentication Setting and Administrator User Name and Password .....	77
2.13	Logging in to the Camera.....	80
2.14	Creating, Modifying or Deleting General Users .....	81

2.15	Changing Initial Settings on the Single Camera page or the Multi-Camera page .....	84
2.16	Configuring Multiple Cameras.....	87
2.17	Format the SD memory card.....	89
2.18	Stop the SD Memory Recording .....	90
2.19	Buffering or Transferring Images by Timer .....	91
2.20	Buffering or Transferring Images by Alarm Signal.....	100
2.21	Transfer the Camera Image in Transport Mode.....	111
2.22	Transfer the Camera Image in Tunnel Mode .....	112
2.23	Specifying Operation Time.....	113
2.24	Controlling External Output Terminal .....	115
2.25	Changing Indicator Display .....	116
<b>3</b>	<b>Camera Maintenance .....</b>	<b>117</b>
3.1	Maintenance page .....	117
3.1.1	Confirming the Status.....	118
3.1.2	Confirming Session Status .....	118
3.1.3	Restarting the Camera .....	119
3.1.4	Updating the Camera Firmware .....	120
3.1.5	Creating Configuration File.....	123
3.1.6	Loading Settings from a Configuration File .....	124
3.1.7	Resetting the Camera to Factory Default .....	125
3.2	Support page .....	126
3.2.1	Seeing Help page.....	126
3.2.2	Seeing Product Information.....	126
3.2.3	Seeing Support Information.....	127
3.3	External I/O .....	128
3.4	FACTORY DEFAULT RESET Button.....	130
3.5	Default Setting List.....	131
3.6	Cleaning.....	140
3.6.1	Cleaning the Main Unit .....	140
3.7	Setting an IP Address on Your PC .....	141
3.8	Using Setup Program.....	142
3.9	Setting Your PC.....	146
3.9.1	Setting the Proxy Server Settings on Web Browser .....	146
3.9.2	Setting UPnP™ to Display Camera Shortcut in My Network Places.....	149

3.9.3	Setting the Internet Temporary File Setting on Web Browser ....	149
3.10	ASCII Character Table .....	150
3.11	File Size and Number of Buffered Images .....	151
3.12	Number of Images on the SD Memory Card .....	152
3.13	Specifications.....	153
	<b>Index.....</b>	<b>157</b>

# 1 Camera Monitoring

## 1.1 Accessing the Camera

1. Start up the web browser on your PC.
2. Enter "**http://IPv4 Address (or URL):Port Number**" on the address bar, and press [Enter] on the keyboard.
  - When port number is 80 (default), you do not need to enter port number. See page 46 for details about port number.
  - For IPv6 connection, see page 15 and page 16, and prepare the requirements. Enter the "**http://(IPv6-registered URL):Port Number**" on the address bar.
  - If the camera image is not displayed, see page 48 and page 49 of the Installation/Troubleshooting.

E.g. **http://192.168.0.253:50000 (in IPv4)**  
**http://XXXXX.viewnetcam.com:50000 (in IPv6)**

3. The Enter Network Password window is displayed, and enter the user name and password that were set, and click [OK].

### **Note**

When [Permit access from guest users] is set on the Security: Administrator page, authentication window will not be displayed.

4. Click the following tabs to display each page.

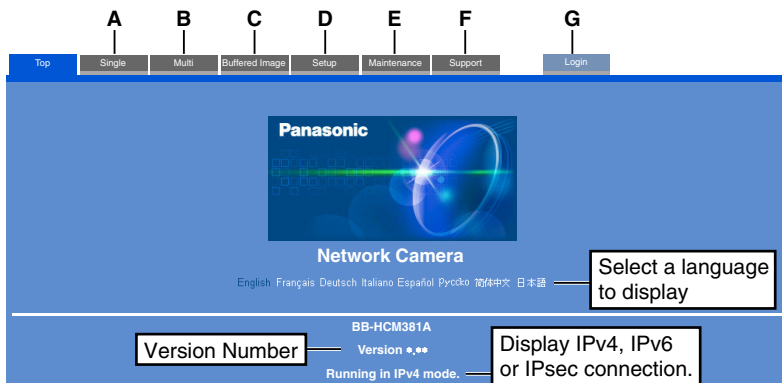

**A** To Single Camera page (page 17)

**B** To Multi-Camera page (page 34)

**C** To Buffered Image page (page 36)

**D** To Setup page (page 41)

**E** To Maintenance page (page 117)

**F** To Support page (page 126)

**G** To log in to the camera (page 80)

**Note**

- When users other than an administrator are accessing the camera, [Setup] and [Maintenance] tab will not be displayed. Additionally, When [Do not permit access from guest users] is set on the Security: Administrator page, [Login] tab will not be displayed.
- If [View Multi-Camera page] or [View Buffered Image page] is not permitted on the General User page, [Multi-Camera] or [Buffered Image] tab will not be displayed.

5. Close the web browser.

## 1.1.1 To Access the Camera in IPv6

You need to prepare the followings to access the camera in IPv6.

- **PC Requirements**

**Operating System:** Windows XP Service Pack 1 or later

**Web Browser:** Internet Explorer 6.0 or later

- **An IPv6 Router**

- **An IPv6 Connection Service**

To connect in IPv6, subscribe to the ISP's "IPv4/IPv6 Dual-Stack" or "IPv6 over IPv4 Tunneling" service. The camera does not work in IPv6-only network.

### IPv6 Domain Name Service

In Windows XP, you cannot access the camera entering IP address on the web browser. You need to enter IPv6 URL registered in the domain name service. We recommend Viewnetcam.com service (see page 25 of the Installation/Troubleshooting) as a domain name service. Ask your ISP about other IPv6 domain name service.

### What is IPv6?

- IPv6 is short for "Internet Protocol Version 6".
- IPv6 was created to address the additional IP addresses that will be needed as the Internet continues to expand.
- IPv6 is expected to gradually replace IPv4, with the 2 coexisting for a number of years during a transition period.
- Though most ISPs (Internet Service Providers) do not yet support IPv6, many local networks already use it. When your ISP supports IPv6, your Panasonic Network Camera will be ready!
- For more information you wish to visit <http://www.ipv6.org/>.

## Setting up the IPv6 Router, your PC, and the Camera

### Setting up the IPv6 Router

Set up the router as you subscribe to the IPv6 service. If the access from WAN side is disabled on the router, enable the TCP packets from WAN side in the packet filtering. See the Panasonic Network Camera support website at <http://panasonic.co.jp/pcc/products/en/netwcam/> for information about the recommended routers.

### Setting up your PC

1. Click [Start] → [All Programs] → [Accessories] → [Command Prompt].
  - Command Prompt window is displayed.
2. Enter "ipv6 install".
  - "Succeeded" is displayed.

#### **Note**

If Windows XP Service Pack 1 or later is not installed, "Succeeded" will not be displayed. Install it on your PC.

3. Enter "ipconfig".
  - If the IPv6 address is properly assigned to your PC, IPv6 address will be displayed on the window.

### Setting up the Camera

Usually, IPv6 address is automatically assigned. If you assign a static IPv6 address, see page 49. To access the camera in IPv6, you need to subscribe to the domain name service such as Viewnetcam.com, and register the URL.

## Confirming that You Can Access the Camera

Confirm that the image is properly displayed (see page 13).



## 1.2 Viewing Single Camera page

1. Access the camera (see page 13).
  - The Top page is displayed.
2. Click the [Single] tab at the top of the page.
  - When Security Warning window is displayed, click [Yes] (see page 18).
  - See page 19 for Security Warning window when using Microsoft Windows XP Service Pack 2.

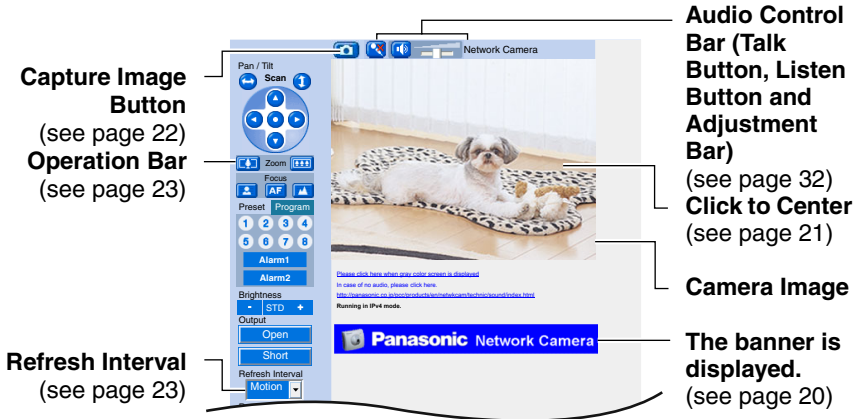

3. Close the web browser.

### Note

- Refresh interval is [Motion] by default. You can change it on the operation bar (see page 23).
- Refresh interval may change depending on the network condition, PC performance and what object you view. SD memory recording or IPsec will also slow refresh interval.
- When displaying video (Motion JPEG), the camera allows up to 30 simultaneous accesses. When trying more than 30 accesses, the 31st user will see a gray screen. (Maximum 30 accesses for a Buffered Image page too.)
- To reduce the data traffic, the video can be automatically changed to refreshing still images on the General User page (see page 81).
- To display the Single Camera page directly, add it to the [Favorites] on the web browser.
- When you view a dark image, enable the color night view mode on the Camera Setup page (see page 69). The image will be brighter, but the refresh interval may slow down and image quality may decrease in a dark place.

## Security Warning window

To view a video (Motion JPEG) or to use audio feature, ActiveX® Controls must be installed. When trying to display a video for the first time, Security Warning window will be displayed. When using Windows XP or Windows 2000, log in as an administrator to install it.

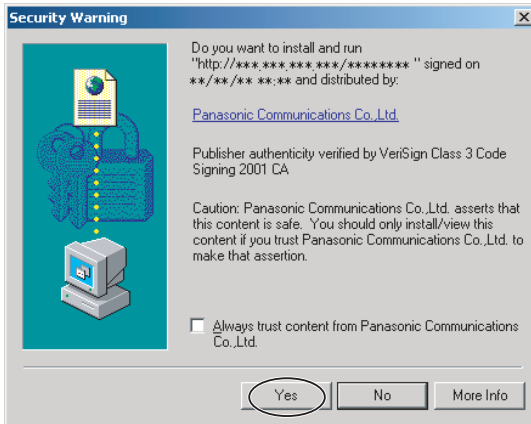

### If you cannot install ActiveX Controls or you cannot see the video in the Internet Explorer

- Click [Tools]→[Internet Options]→[Security] tab and click [Custom level] on the web browser.
  - (1) Check "Prompt" in "Download signed ActiveX Controls".
  - (2) Check "Enable" in "Run ActiveX Controls and plug-ins".
- ActiveX Controls can be installed from the file on the Setup CD-ROM.
  - (1) Restart the PC.
  - (2) Confirm that Internet Explorer is closed.
  - (3) Double-click"ocx\ActiveXInst.exe" on the Setup CD-ROM.

#### Note

- When the IP address was changed for the camera, enter it on the address bar.
- Video may not be displayed quickly or audio may not be listened immediately. Wait for a while.
- If you use a proxy server, set the web browser not to access the proxy server (see page 146).
- In some corporate network environments a firewall may be used for security purposes. It is possible that this may prevent motion video from being displayed. In this situation we suggest:
  - Contact your network administrator.
  - Try using regularly refreshed images.

## Security Warning window on Microsoft Windows XP Service Pack 2

To view a video (Motion JPEG) or to use audio feature, ActiveX Controls must be installed.

Follow the steps shown below to install ActiveX Controls.

1. Click the warning displayed above the tabs, and click [Install ActiveX Control...].

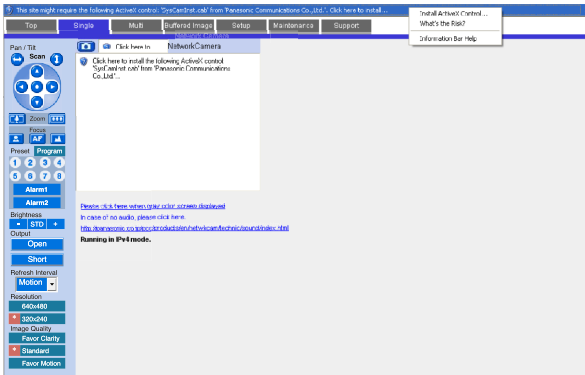

2. Click [Install].

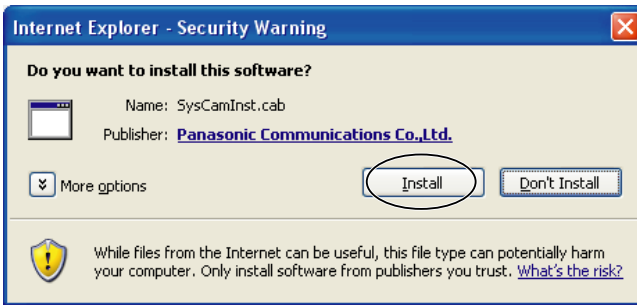

## The Banner

When the camera accesses the Internet, the banner displays product information about cameras or announcements about the latest firmware, etc. from Panasonic. Whether or not to display the banner can be set at Banner Display (see page 84).

### **Note**

- The banner is displayed when [Yes] is checked for Allow Access from the Internet on the Automatic Setup page, or when [Enable] is checked for Auto Port Forwarding on the UPnP page for the Connection Mode of Static or DHCP.
- Even if [Yes] is checked for Allow Access from the Internet on the Automatic Setup page, or [Enable] is checked for Auto Port Forwarding on the UPnP page for the Connection Mode of Static or DHCP, when the camera is not connected to the Internet, ☒ is displayed.

## 1.2.1 Auto Centering the Image (Click to Center)

Using your mouse, click any portion of the camera image. As long as it is within the pan/tilt range of the camera, the image will automatically move to place the selected point in the center of the screen.

1. Move the cursor to the desired point.



2. Click it.

- The clicked point is centered.
- See page 24 for the pan/tilt operation.



### **Note**

- When End Display appears on the operation bar, Click to Center does not work beyond the pan/tilt end (see page 23).
- The clicked position may slightly miss the center depending on the lens direction.
- If Click to Center is not permitted on the General User page (see page 81), Click to Center does not work.

## 1.2.2 Capturing a Still Image

A still image can be saved on your PC.

1. Operate pan/tilt and select a resolution to display an image.
2. Click the capture image button.

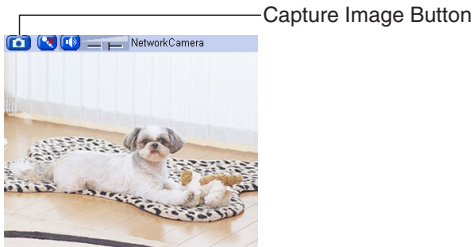

- The camera image opens in another window.
3. Right-click the image, and select [Save Picture As...].

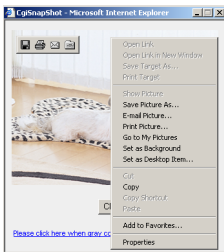

- Save as dialog box is displayed.
4. Specify the location, and click [Save].
    - Camera image is saved at that location.
  5. Click [Close].

## 1.2.3 Using Operation Bar

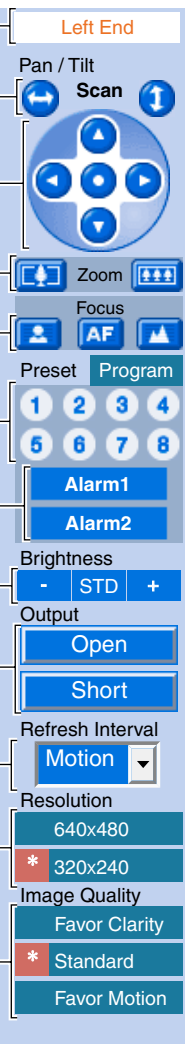
- 
- (1) **Left End**
- (2) **Pan / Tilt Scan**
- (3) **Pan/Tilt/Home Position**
- (4) **Zoom**
- (5) **Focus**
- (6) **Preset**
- (7) **Alarm**
- (8) **Brightness**
- (9) **Output**
- (10) **Refresh Interval**
- (11) **Resolution**
- (12) **Image Quality**
- (1) End Display and Preset Display:** When the pan/tilt has reached the end (Left End, Right End, Up End and Down End), End Display appears. When the zoom or focus operation has reached the end, Wide End, Tele End, Near End, or Far End appears. When clicking a preset button, the preset name appears.
- (2) Pan Scan/Tilt Scan:** Moves the lens throughout the horizontal (↔) or vertical (↑↓) range, and returns to the original position.
- (3) Pan/Tilt/Home Position:** Controls lens direction. Pan (◀: Left, ▶: Right), Tilt (▲: Up, ▼: Down) and Home Position (●: Center [Default])
- (4) Zoom Buttons:** Zooms in or out on the camera image.
- (5) Focus Buttons:** Used to adjust the focus.
- (6) Preset Button:** Applies the camera direction to a preset position. You can preset 8 positions (see page 28—page 31).
- (7) Alarm Position:** When the External I/O detects a signal, the camera can be set up to turn to this position. Only an administrator can operate it (see page 28).
- (8) Brightness:** Changes brightness in 9 steps including [STD] (Standard). Clicking [-] or [+] changes the image brightness.
- (9) Output Control:** Controls the output signals of the External I/O.
- (10) Refresh Interval:** Sets a refresh interval. (Motion—60-second interval)
- (11) Resolution:** Selects [640 x 480] or [320 x 240] (default) pixels.
- (12) Image Quality:** Selects the image quality.
- [Favor Clarity] optimizes the image for good clarity.
  - [Standard] keeps the standard quality. (default)
  - [Favor Motion] optimizes the image for motion display.

### Note

When the camera image is not displayed correctly, click [Refresh] at the tool bar on the web browser. The image will be refreshed.

## Pan/Tilt Operation

The pan scan and tilt scan buttons automatically move the lens horizontally from  $-175^{\circ}$  to  $+175^{\circ}$  and vertically from  $-120^{\circ}$  to  $0^{\circ}$  in mounting on the table and from  $0^{\circ}$  to  $+90^{\circ}$  in mounting on the ceiling, and the lens returns to the current position. Use Click to Center feature to stop scanning. Each pan/tilt arrow moves the lens Up, Down, Right, Left, and the home position button moves it to Home Position.

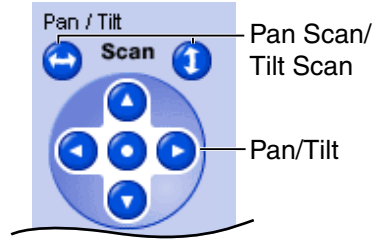

### Pan/Tilt range when the camera is on a table

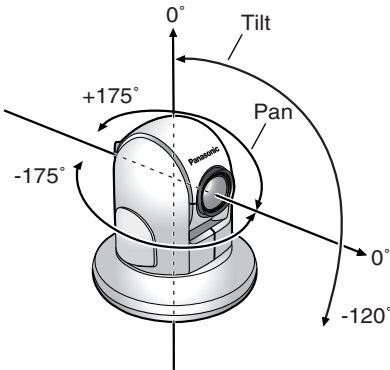

### Pan/Tilt range when the camera is mounted on a ceiling

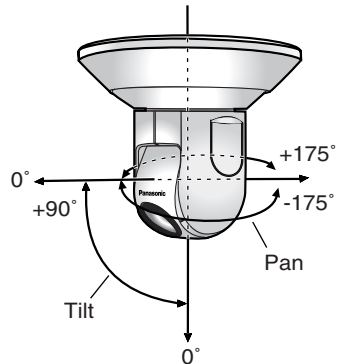

### Note

- When the power is on, do not manually pan or tilt the camera. Doing so may damage the Pan/Tilt operation, or cause the Preset buttons to pan or tilt the camera to the wrong position. If you accidentally pan or tilt the camera manually, restart the camera.



## 1.2.4 Zooming In and Out

Network Camera has a 42x magnifying capacity: the 21x magnifying capacity of the optical zoom and 2x magnifying capacity of the digital zoom. Zoom button increases or decreases the size of the object on the Single Camera screen. Tele button zooms in, and Wide button zooms out. The zooming feature has 12 steps (10 steps of Optical Zoom and 2 steps of Digital Zoom).

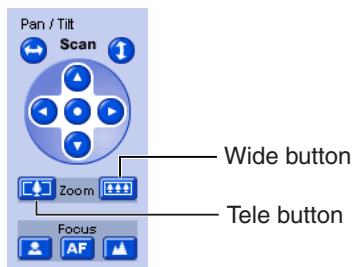

### Note

- The optical zoom automatically switches to the digital zoom.
- The definition in the image may decrease when using the digital zoom.
- The position you click may considerably deviate from the center of the image when using the Click to Center feature on a large zoom scale.

## 1.2.5 Automatic and Manual Focusing

Focus button adjusts the focus. Network Camera has Automatic and Manual Focusing features. AF (Automatic Focus) button automatically allows the lens to focus on objects. Manual focusing starts by pressing Near or Far button. Near button enables the lens to shorten the focal distance, and Far button lengthens it, manually. Manual focusing feature has 40 steps.

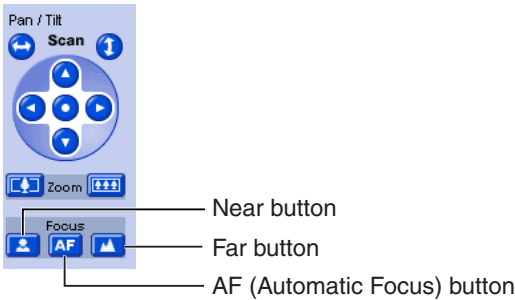

### Note

- Some objects are difficult to focus on by auto focusing. In the objects shown below, it may take a while to focus on, or may not focus on them. Press the AF button and put it into operation again. When the objects are still out of focus, adjust the focus using manual focusing, or change the objects using Pan/Tilt operation or Zooming features. Manual focusing starts by pressing Near or Far button. Press AF button for turning it into Automatic Focusing.

### The objects that are difficult to focus on by AF button



Objects without contrast  
(e.g., White wall)



Horizontally striped  
objects

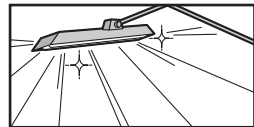

High-luminance objects  
(e.g., fluorescent lights)



Light-dotted object in  
the dark (e.g., night view)



Objects viewed  
through glass

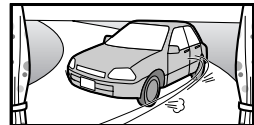

Objects moving fast

- When positioning the camera in front of a window to view images on the other side of the glass, set the Automatic Focus Range setting to "Normal" (page 69).
- When positioning the camera within 1 m (40 inches) of the object you wish to view, set the Automatic Focus Range setting to "Macro" (page 69).
- Fingerprints, dust, stains, etc. on the lens can degrade the performance of the Automatic Focusing feature. Wipe the lens with lens cleaning paper.
- The image may be out of focus, if it is too near, or depending on the zoom position. Move the object, or adjust the zoom position.

### Minimum object distance

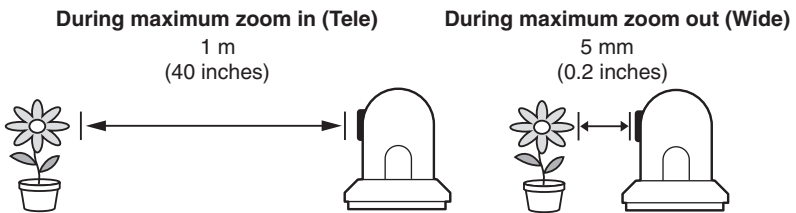

## 1.2.6 Setting Home Position/Alarm Position/Preset Button

### Registering Home Position/Alarm Position

A home position or 2 alarm positions can be registered. When restarted, the camera takes a home position. If the Lens Position When Triggered setting is set (see page 102), the camera takes a alarm position after the External I/O detects a signal. See page 128 for the External I/O.

1. Click [Program].
  - [Program] switches to [Cancel]. Click [Cancel] to quit without saving changes.
2. Pan and tilt the camera to a desired position.
3. Zoom to the desired position.
4. Adjust the focusing if necessary.
5. Click the home position button or the alarm position button.
6. Click [Save] to register, or click [Back] and [Cancel] to cancel.
  - If "Success!" is displayed, click [Back].

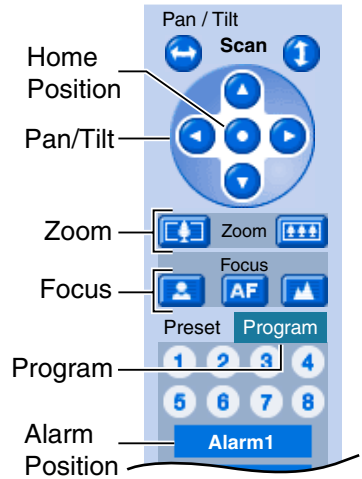

## Registering a Preset Button

8 camera positions can be stored as presets. These buttons can be changed (see page 31).

- Registered buttons are shown in blue.
- Unregistered buttons are shown in white.

1. Click [Program].
  - [Program] switches to [Cancel]. Click [Cancel] to quit without saving changes.
2. Pan and tilt the camera to a desired position.
3. Zoom to the desired position.
4. Adjust the focusing if necessary.
5. Click a preset button (1—8) to register.
 

E.g.:  
Setting "UpperLeft" for the preset 1.
6. Enter the preset name.
  - Maximum 15 characters.
  - Enter ASCII characters (see page 150) or characters in each language. But [Space], ["], ['], [&], [<] and [>] are not available.
7. Click [Save] to register, or click [Back] and [Cancel] to cancel.
  - If "Success!" is displayed, click [Back].

### Note

- When registering preset buttons, the camera also saves brightness and white balance settings.
- Only an administrator can register preset buttons.

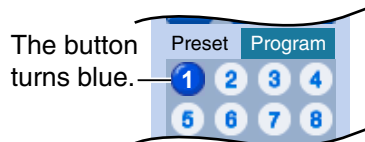
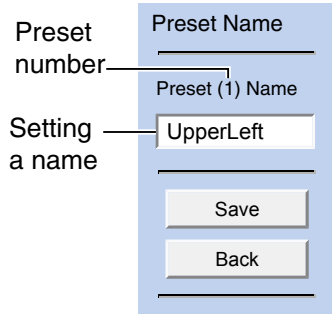
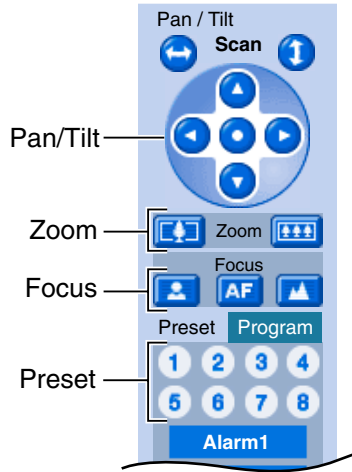

## Viewing the Image

1. Click the home position, alarm position or registered preset button.
  - The camera takes each position, and the image is displayed.

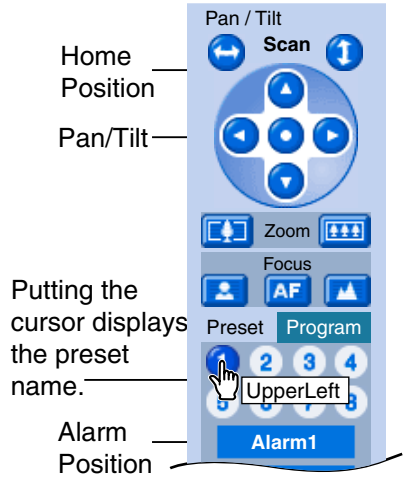

## Changing or Deleting the Settings

1. Click [Program].
  - [Program] switches to [Cancel]. Click [Cancel] to quit without saving changes.
2. Pan and tilt the camera to a desired position, or skip to step 5 if deleting a preset.
3. Zoom to the desired position.
4. Adjust the focusing if necessary.
5. Click the home position, alarm position or a preset button (1—8).
6. Click [Save] after setting the preset name or click [Delete].
  - If you quit to change or delete settings, click [Back], and then [Cancel].
  - If "Success!" is displayed, click [Back].

### Note

The home position or the alarm position cannot be deleted, and these position names cannot be changed either.

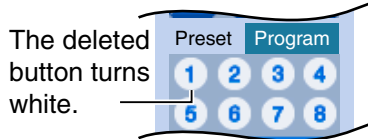
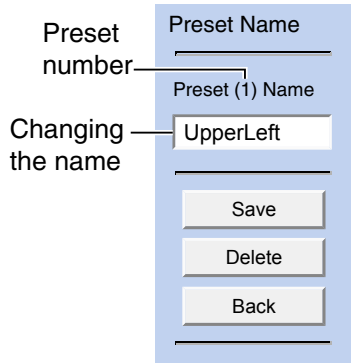
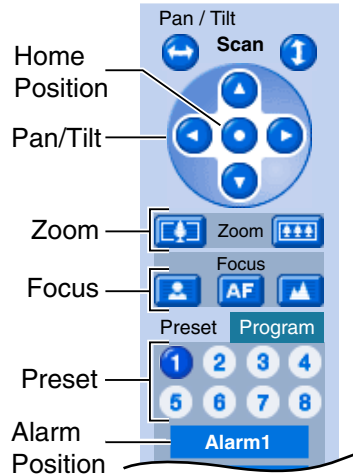

## 1.3 Listening to Camera Audio—Talking to the Camera

1. Access the camera (see page 13).
  - The Top page is displayed.
2. Click the [Single] tab at the top of the page.
3. The Audio Control Bar (Talk Button, Listen Button and Adjustment Bar) is displayed at the top of the screen. Listening or Talking is selected using the 2 icons. For general users, the feature must be enabled, otherwise it will not be displayed.

### Audio Feature

**Listen Button** —————

**Talk Button** —————

 : You can talk from the camera using the PC's microphone. Clicking the button stops temporarily the audio.

 : The audio is stopped. Clicking the button again starts the Talk feature.

 : You can listen to the audio around the camera. Clicking the button temporarily stops the audio.

 : The audio is stopped.

**Adjustment Bar** —————  
(Volume adjustment only for listening)



————— This slider adjusts the volume. To the right side, the volume is larger. To the left side, the volume is smaller.

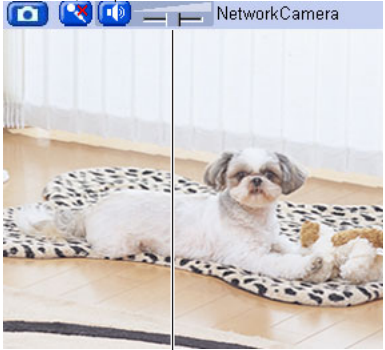

#### Note

- An external microphone and speaker must be connected to the camera (via the Audio/Video Cable) in order to use the Listen and Talk buttons.
- Talk button and Listen button cannot be used simultaneously. Talk feature is stopped during listening. Talk feature can be used only for a user. Listen feature can be used for maximum 10 users. If the audio is interrupted, reduce



the max. bandwidth (see page 44 and page 49). In this case, the number of users for listening are reduced.

- Audio features such as camera microphone sensitivity and mute during pan/tilt can be set up on the Audio page (see page 75).
- If you are running other applications or opening multiple windows, the audio may be interrupted or delayed.
- When the image is refreshed during any operation such as preset registration or a web browser refresh, the volume is reset to the default (midrange) position. Audio that was muted is enabled.
- The audio may be interrupted due to your PC's performance or network environment. Reduce the max. bandwidth (see page 44 and page 49).
- If the camera is accessed while the PC user visits other websites, the active microphone may pick up audio from the PC's speakers. Be careful with it.
- Talk feature cannot be used from a PC when the camera is accessed via a proxy server.
- If you cannot listen to the audio or talk from your PC, see 2.5 Audio Problems in the Troubleshooting section of the Installation/Troubleshooting.

## 1.4 Viewing Multi-Camera page

To view multiple cameras on the Multi-Camera page, you need to configure each camera on the Multi-Camera Setup page (see page 87).

1. Access the camera (see page 13).
  - The Top page is displayed.
2. Click the [Multi] tab at the top of the page.



- Multi-Camera page can display up to 12 camera images.

### Capture Image Button (see page 22)

Switches cameras to display. If you select [All] at the View Type, video (Motion JPEG) or audio buttons cannot be displayed.

Selects [320 x 240] (default) or [160 x 120] pixels resolution.

Selects a refresh interval (Motion—60-second interval).

When clicking the camera name, the Single Camera page is displayed on another window.

### Audio Control Bar (Talk button, Listen button and Adjustment Bar) (see page 32)

3. Close the web browser.

### Note

- When selecting [All] at the View Type, all images are displayed in 160 x 120 pixels resolution and the audio features (Talk and Listen) cannot be used.

- 640 x 480 pixels image cannot be displayed on the Multi-Camera page.
- When viewing video (Motion JPEG), we recommend using an Ethernet switching hub instead of the repeater hub to prevent degradation in video display.
- Due to the network congestion or the number of accesses, the refresh interval may slow down.
- When the refresh interval is slow, restrict the bandwidth on the Network page (see page 47 and page 52). The refresh interval may be improved.
- To reduce the data traffic, the video can be automatically changed to refreshing still images on the General User page (see page 81).
- When viewing 4 cameras on the Multi-Camera page, you may need 3 to 4 Mbps bandwidth. If the bandwidth is not enough, the refresh interval may slow down.

### **When the image is not displayed on the Multi-Camera page**

- Confirm that the Internet IP address is specified for each camera and that each camera is connected to the Internet. For Internet access, local IP addresses (192.168.xxx.xxx) cannot be used.
- Confirm the settings on the Multi-Camera Setup page (see page 87).
- Confirm that the web browser is not accessing the proxy server (see page 146).

### **When setting [Do not permit access from guest users] on the Security: Administrator page**

- An authentication window is displayed in camera access. Enter the administrator's or the general user's user name and password.
- When you view the images on the Multi-Camera page, all authentication windows of the configured cameras are displayed. Enter the administrator's or the general user's user name and password registered for each camera.

## 1.5 Viewing Buffered Image page

To buffer the images on the internal memory, you need to set up image transfer settings (see page 91 or page 100). You can view buffered images on this Buffered Image page.

### Note

- Sound cannot be buffered on the Buffered Image page.
1. Access the camera (see page 13).
    - The Top page is displayed.
  2. Click the [Buffered Image] tab at the top of the page.



3. Click the trigger number.

The trigger number is displayed (see page 91 or page 100).

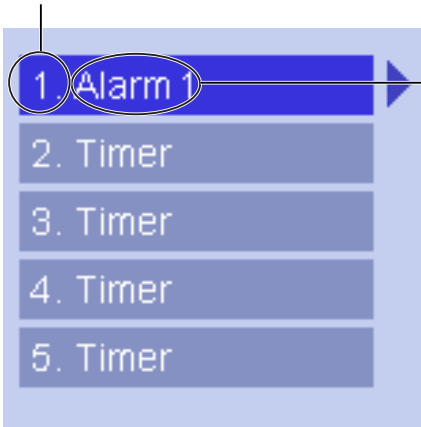

The trigger is displayed (see page 91 or page 100).

4. Display images clicking buttons below.

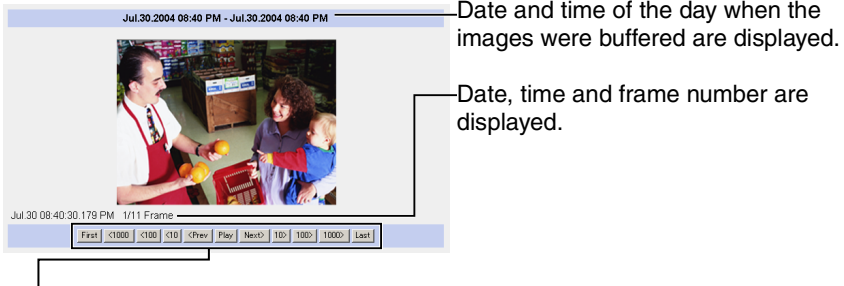

**[Play]:**

The buffered images are displayed continuously.

**[<Prev] or [Next>]:**

The previous or next image is displayed.

**[<First], [<1000], [<100], [<10] or [10>], [100>], [1000>], [Last]:**

First, 10th, 100th, 1000th image before or last, 10th, 100th, 1000th image after of the displayed image appears.

**Note**

- Date, Time and frame number are not displayed in play mode.
- A still image can be saved on the Buffered Image page, if you are not playing images on it. Put the cursor on the image, and right-click it. Then select [Save Picture As...].
- Maximum number of buffered images change depending on resolution, image quality and what object the camera buffers. At the 320 x 240 pixels resolution and the standard quality, the camera buffers about 125 frames. (If 3 triggers are enabled [maximum 5 triggers], the internal memory or the SD memory card capacity is divided into 3 sections. In this case, each trigger can buffer about 40 images.) See page 151 for the internal memory capacity. See page 152 for the SD memory card capacity.

## 1.5.1 Deleting Buffered Images

If you intend to delete images for each transfer condition, click [Delete Buffered Images] on the Image Buffer/Transfer page (see page 91 or page 100).

### **Note**

- If you click [Save] on the Image Buffer/Transfer page, all buffered images on the SD memory card are deleted.
- If you are buffering images on the internal memory, the following operations also delete all buffered images.
  - Turning off the camera.
  - Saving the Date and Time page.
  - Restarting, updating firmware or resetting the camera to factory default.
  - Changing the setting for [Enable Image Buffer/Transfer] (see page 91 or 100).

## 1.6 Viewing Still Images on Your Cell Phone

You can view still images over the Internet from a compatible cell phone.

Enter "**http://IP address (or URL):Port Number/Mobile**" on a cell phone and press [OK].

- When the port number is set to 80 (default), it is not required.

E.g. <http://202.208.167.XXX:50000/Mobile>  
(or [XXXXX.viewnetcam.com:50000/Mobile](http://XXXXX.viewnetcam.com:50000/Mobile))

- The camera must be allowed the Internet access for cell phone access.
- When an authentication window is displayed, enter the administrator's or the general user's user name and password.
- A still image is displayed. (Video [Motion JPEG] cannot be displayed.)

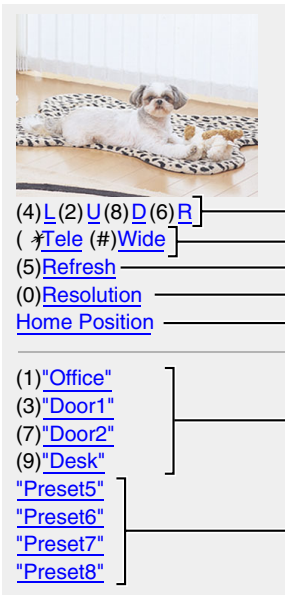

Pressing 2, 4, 6 or 8 on the cell phones allows you to pan or tilt the camera in four directions: Left, Up, Down or Right.

Pressing \* allows you to zoom in, and pressing # allows you to zoom out.

Pressing 5 will refresh the image.

160 x 120 resolution is displayed at the first access. Pressing 0 switches the resolution to 320 x 240.

Executing [Home Position] moves the lens to the home position.

Pressing 1, 3, 7 or 9 on the keypad allows you to use the first four registered preset buttons.

Registered presets 5—8 are available by activating the link on the cell phone page.

### Note

- Audio feature does not work on cell phones.
- If the features are not permitted on the General User page (see page 81), the buttons related with the features are not displayed.

- If the image is not displayed properly, try the following 2 URLs.
  1. **http:// IP address(or URL):Port Number/MobileH** for HTML.  
(or XXXXX.viewnetcam.com:50000/MobileH)
  2. **http:// IP address(or URL):Port Number/MobileX** for XHTML.  
(or XXXXX.viewnetcam.com:50000/MobileX)
- When pan, tilt, or zoom reaches the end, the keypad number and character disappear.

E.g.: The pan reaches the left end.

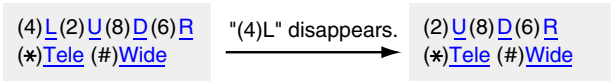

- Some cell phones are not compatible with Panasonic Network Cameras. Some phones may allow viewing only on port 80, and some may not support password authentication. See the Panasonic Network Camera support website at <http://panasonic.co.jp/pcc/products/en/netwcam/> for a cell phone model list, and the compatibility level which has been verified with the Panasonic Network Camera.
- Some cell phones display images not at the specified resolution but at a decreased size.



## 2 Various Camera Features

### 2.1 Using Camera Features

1. Access the camera (see page 13).
  - The Top page is displayed.

#### Note

- When [Permit access from guest users] is set on the Security: Administrator page, click [login] button and log in as an administrator.
  - When users other than an administrator are accessing the camera, the [Setup] and [Maintenance] tabs are not displayed.
  - If [View Multi-Camera page] or [View Buffered Image page] is not permitted on the General User page, [Multi-Camera] or [Buffered Image] tab will not be displayed.
2. Click [Setup] tab at the top of the page.

Top Single Multi Buffered Image Setup Maintenance Support

Basic

(1) Network(IPv4) (2) Network(Pv6) (3) IPsec (4) L2TP (5) Viewnetcam.com (6) Date and Time (7) Camera (8) Audio

Account

(9) Administrator (10) General User

Advanced

(11) Image Display (12) Multi-Camera (13) Buffer/Transfer (14) Operation Time (15) External Output (16) Indicator Control

### Network(IPv4)

Set up network configuration.  
 Select "Automatic Setup" if you connect the camera to the router and wish to set it up automatically.  
 Select "Static" if you wish to assign a static IP address to the camera.  
 Select "DHCP" if you are using the DHCP function of your router or ISP.

Connection Mode		
Connection Mode	Current Setting	
<a href="#">Automatic Setup</a>	X	Configure network settings automatically
<a href="#">Static</a>		Assign static IP address to the camera.
<a href="#">DHCP</a>		Get IP address from DHCP server

---

## Basic

- (1) **Network (IPv4)** Configures the IPv4 network settings to connect the camera to the network (see page 44).
- (2) **Network (IPv6)** Configures the IPv6 network settings to connect the camera to the network (see page 49).
- (3) **IPsec** Enables IPsec (Transport or Tunnel mode) (see page 53).
- (4) **UPnP** Enables automatic port forwarding or shortcut to the camera (see page 63).
- (5) **Viewnetcam.com** Registers with the Viewnetcam.com service (see page 65).
- (6) **Date and Time** Sets the date and time, automatic time adjustment and adjust clock for daylight saving time settings (see page 67).
- (7) **Camera** Sets camera name, white balance, AC power source frequency, automatic focus range, mounting type, pan/tilt range, return to specified position, color night view, and vertical resolution settings (see page 69).
- (8) **Audio** Sets output, volume, PC audio input timeout, input, camera microphone sensitivity and mute during pan/tilt settings (see page 75).

---

## Account

- (9) **Administrator**<sup>\*1</sup> Sets authentication setting and administrator security (user name and password) (see page 77).
- (10) **General User**<sup>\*1</sup> Sets general user security (user name and password) and general user's access level (see page 81).

---

## Advanced

- (11) **Image Display** Sets resolution, image quality and refresh interval of Single Camera and Multi-Camera page, time stamp setting, and language (see page 84).
- (12) **Multi-Camera**<sup>\*1</sup> Sets the camera IP address or host name, camera name on the Multi-Camera page (maximum 12 cameras) (see page 87).

<sup>\*1</sup> If you change [Administrator], [General User], or [Multi-Camera Setup page] settings, changes will not be applied to the video (Motion JPEG) viewers. Restart the camera to make changes applied to all video viewers.

- (13) Buffer/Transfer** Sets image buffer or transfer by timer or alarm. (see page 91 or page 100).
- (14) Operation Time** Sets time period to display camera images (see page 113).
- (15) External Output** Sets the digital output terminal of the External I/O (see page 115).
- (16) Indicator Control** Sets indicator display (see page 116).

## 2.2 Connecting the Camera to Your IPv4 Network

The Network page offers three options to configure the camera in IPv4.

- [Automatic Setup] automatically assigns an unused IP address to the camera, and uses UPnP™ (Universal Plug and Play) to configure your router.
  - [Static] allows the user to use a specific IP address.
  - [DHCP] is offered for ISPs who require this option.
1. Click [Network (IPv4)] on the Setup page.
  2. Click a connection mode.

Connection Mode	
Connection Mode	Current Setting
<a href="#">Automatic Setup</a>	Normally sets Automatic Setup.
<a href="#">Static</a>	Uses a static IP address.
<a href="#">DHCP</a>	Uses ISP DHCP server function.

- Each page is displayed (see page 44—page 45).
3. Enter each parameter in the proper data field.

### Automatic Setup

The camera automatically obtains the network settings (subnet mask, default gateway and DNS server address) utilizing a DHCP feature on the router. The camera also automatically searches the unused IP address on your network. If you select [Yes] at the Allow Access from the Internet, the camera automatically enables port forwarding by using UPnP™. In this case, the camera automatically searches the unused port number on your network in the order from 50000 to 50050.

<b>Allow Access from the Internet</b>	
<input type="radio"/> Yes	
<input checked="" type="radio"/> No	
<b>Max. Bandwidth Usage</b>	
Unlimited ▾	
<b>Connection Type</b>	
Auto Negotiation ▾	
<input type="button" value="Save"/> <input type="button" value="Cancel"/>	

- Clicking [Cancel] takes you back to the previous page without saving changes.

**DHCP Setup**

Network Configuration from Setup Program	
<input checked="" type="checkbox"/> Enable	
Internet Connection	
Port No.	<input type="text" value="80"/>
Host Name	<input type="text"/>
Default Gateway	
Default Gateway	<input type="text"/>
DNS	
DNS Server 1	<input type="text"/>
DNS Server 2	<input type="text"/>
Max. Bandwidth Usage	
<input type="text" value="Unlimited"/>	
Connection Type	
<input type="text" value="Auto Negotiation"/>	
<input type="button" value="Save"/> <input type="button" value="Cancel"/>	

**Static Setup**

Network Configuration from Setup Program	
<input checked="" type="checkbox"/> Enable	
Internet Connection	
Port No.	<input type="text" value="80"/>
IP Address	<input type="text" value="192.168.0.253"/>
Subnet Mask	<input type="text" value="255.255.255.0"/>
Default Gateway	
Default Gateway	<input type="text"/>
DNS	
DNS Server 1	<input type="text"/>
DNS Server 2	<input type="text"/>
Max. Bandwidth Usage	
<input type="text" value="Unlimited"/>	
Connection Type	
<input type="text" value="Auto Negotiation"/>	
<input type="button" value="Save"/> <input type="button" value="Cancel"/>	

- Clicking [Cancel] takes you back to the previous page without saving changes.

**4. Click [Save] when finished.**

- New settings are saved.
- When finished, the following page is displayed.

**New settings are saved.**

New settings are saved. Please restart the camera.

Note: (1) All the buffered images will be erased when restarted.

(2) Please use Setup Program to find out the camera on your network when you select "Automatic Setup" or "DHCP".

**Note**

The current network settings are shown on the Status page in the Maintenance section (see page 118).

**5. Click [Restart].**

- The camera restarts, and the Top page is displayed.

**Note**

- When you do not know the camera IP address while setting [Automatic Setup] or [DHCP Setup], you can search it by using the Setup Program (see page 142).

- Checking [Yes] for [Allow Access from the Internet] on [Automatic Setup] may not display the Top page, because the port number may change. Use the Setup Program to access the camera.
- If the camera is restarted, all buffered images on the internal memory are deleted. The buffered images on the SD memory card are not deleted.

Setting	Description
Allow Access from the Internet (Automatic Setup Only)	<ul style="list-style-type: none"> <li>• Allow Access from the Internet setting automatically configures the router's Port Forwarding setting (some routers call it "Address Translation", "Static IP Masquerade", "Virtual Server" or "Port Mapping"). To enable Internet access to the camera, check [Yes]. In this case, the camera automatically searches the unused port number on your network in the order from 50000 to 50050. To disable Internet access to the camera, check [No].</li> </ul>
Network Configuration from Setup Program (Static/DHCP Only)	<ul style="list-style-type: none"> <li>• If you prohibit the Setup Program from changing the network settings, clear the check box.</li> </ul>
Port Number (Static/DHCP Only)	<ul style="list-style-type: none"> <li>• The port number is 80 by default. When you use multiple cameras with a router on your network, each camera must be assigned its own port number (see page 28 "1.10 Connecting the Camera to a Router Not Supporting UPnP™ (IPv4 Only)" in the Installation/Troubleshooting).</li> <li>• Do not set the following port numbers. E.g., FTP: 20 and 21, Telnet: 23, SMTP: 25, DNS: 53, POP3: 110, HTTPS: 443, ICQ: 4000 and IRC: 6661—6667.</li> <li>• Enter only the number (1—65535).</li> <li>• Some ISPs do not allow you to use port 80. Ask your ISP or network administrator about the accessible port number over the Internet.</li> </ul>
<ul style="list-style-type: none"> <li>• IP address</li> <li>• Subnet Mask</li> </ul> (Static Only)	<ul style="list-style-type: none"> <li>• If your ISP or network administrator specifies the IP address and subnet mask, enter them in each data field.</li> <li>• If you use the camera on the LAN, set the IP address in the same class as your PC (see page 141).</li> <li>• Set 4 digits (0—255) and 3 periods such as "192.168.0.253". But "0.0.0.0" and "255.255.255.255" are not available.</li> </ul>

Setting	Description
Host Name (DHCP Only)	<ul style="list-style-type: none"> <li>• If your ISP uses the DHCP function which automatically assigns the IP address to the camera, enter the ISP-assigned host name. (Host name may be used as an authentication.)</li> <li>• Enter ASCII characters for the host name (see page 150). But [Space], ["], ['], [&amp;], [&lt;] and [&gt;] are not available.</li> </ul>
Default Gateway <sup>1</sup> (Static/DHCP Only)	<ul style="list-style-type: none"> <li>• If you have the assigned Default Gateway address by your ISP or network administrator, enter it in this data field.</li> <li>• Set 4 digits (0—255) and 3 periods such as "192.168.0.253". But "0.0.0.0" and "255.255.255.255" are not available.</li> </ul>
DNS Server Address <sup>1</sup> (Static/DHCP Only)	<ul style="list-style-type: none"> <li>• DNS server address is required in the following conditions. <ul style="list-style-type: none"> <li>• Transferring camera images by E-mail or FTP</li> <li>• Setting cameras by their host names on the Multi-Camera Setup page</li> <li>• Using the Viewnetcam.com service</li> </ul> </li> <li>• If you have the assigned DNS server addresses by your ISP or network administrator, enter them in this data field. They usually have two addresses.</li> <li>• Set 4 digits (0—255) and 3 periods such as "192.168.0.253". But "0.0.0.0" and "255.255.255.255" are not available.</li> </ul>
Max. Bandwidth Usage	<ul style="list-style-type: none"> <li>• The bandwidth can be restricted.</li> <li>• Select the maximum bandwidth usage from [Unlimited] to [0.1 Mbps].</li> <li>• This setting is valid in both IPv4/IPv6.</li> </ul> <p><b>Note</b></p> <p>Set the maximum bandwidth usage seeing the following file sizes. These are examples for a JPEG file with a standard image quality. File sizes may change depending on the image quality or how bright the object is.</p> <p>160 x 120 pixels: About 5 KB (40 Kbit)  320 x 240 pixels: About 16 KB (128 Kbit)  640 x 480 pixels: About 33 KB (264 Kbit)</p>

<b>Setting</b>	<b>Description</b>
Connection Type	<ul style="list-style-type: none"><li>• Select [Auto Negotiation] normally. If you cannot access the camera, see page 48 "The Top page is not displayed." in the Installation/Troubleshooting.</li><li>• This setting is valid in both IPv4/IPv6.</li></ul>

\*1 If you automatically obtain the IP address from the DHCP server, you do not need to set it.



## 2.3 Connecting the Camera to Your IPv6 Network

The Network page offers two options to configure the camera in IPv6.

- [Automatic Setup] automatically assigns an IPv6 address to the camera.
- [Static] allows the user to use a specific IPv6 address.

### Note

IPv6 is the expanded protocol created for future Internet expansion. Your network and your ISP must support IPv6 before you can use this feature.

1. Click [Network (IPv6)] on the Setup page.
2. Click a connection mode.

Connection Mode	
Connection Mode	Current Setting
<a href="#">Automatic Setup</a>	Normally sets Automatic Setup.
<a href="#">Static</a>	Uses a static IP address.

3. Enter each parameter in the proper data field.

### Automatic Setup

The camera is automatically assigned an IPv6 prefix from the IPv6 router, and produces the original IPv6 address from the IPv6 prefix. If you select [No] at the Allow Access from the Internet, the camera can be accessed only from the LAN that has an same IPv6 prefix as the camera.

<b>Allow Access from the Internet</b>	
<input type="radio"/> Yes	
<input checked="" type="radio"/> No	
<b>DNS</b>	
DNS Server 1	<input type="text"/>
DNS Server 2	<input type="text"/>
<b>Max. Bandwidth Usage</b>	
	[Unlimited ▼]
<b>Connection Type</b>	
	[Auto Negotiation ▼]
<input type="button" value="Save"/> <input type="button" value="Cancel"/>	

- Clicking [Cancel] takes you back to the previous page without saving changes.

### Static Setup

You can assign a static IPv6 address to the camera. If you select [No] at the Allow Access from the Internet, the camera can be accessed only from the LAN that has an same IPv6 prefix as the camera.

Allow Access from the Internet  
 Yes  
 No

Internet Connection  
Port No: 80  
IP Address: [ ]

Default Gateway  
Default Gateway: [ ]

DNS  
DNS Server 1: [ ]  
DNS Server 2: [ ]

Max. Bandwidth Usage  
Unlimited

Connection Type  
Auto Negotiation

Save Cancel

- Clicking [Cancel] takes you back to the previous page without saving changes.
4. Click [Save] when finished.
- New settings are saved.
  - When finished, the following page is displayed.

**New settings are saved.**

---

New settings are saved. Please restart the camera.

Note: Buffered images will be erased when restarted.

---

Restart

### Note

The current network settings are shown on the Status page in the Maintenance section (see page 118).

**5.** Click [Restart].

- The camera restarts, and the Top page is displayed.

**Note**

- When you do not know the camera IP address while setting [Automatic Setup], you can search it by using the Setup Program (see page 142). Or you can search it on the Status page (see page 118) after accessing the camera in IPv4.
- If the camera is restarted, all buffered images on the internal memory are deleted. The buffered images on the SD memory card are not deleted.

Setting	Description
Allow Access from the Internet (Automatic Setup Only)	<ul style="list-style-type: none"> <li>• If [Yes] is selected at the Allow Access from the Internet, you can access the camera from the Internet. If [No] is selected, the camera can be accessed only from the LAN that has an same IPv6 prefix as the camera.</li> </ul>
Port Number (Static Only)	<ul style="list-style-type: none"> <li>• The port number is 80 by default. The port number must be unique for each terminal on your network.</li> <li>• Do not set the following port numbers. E.g., FTP: 20 and 21, Telnet: 23, SMTP: 25, DNS: 53, POP3: 110, HTTPS: 443, ICQ: 4000 and IRC: 6661—6667.</li> <li>• Enter only the number (1—65535).</li> <li>• Some ISPs do not allow you to use port 80. Ask your ISP or network administrator about the accessible port number over the Internet.</li> </ul>
IP address (Static Only)	<ul style="list-style-type: none"> <li>• Enter a global address. You do not need to enter prefix length.</li> <li>• IPv6 address consists of 8 hexadecimal digits divided with ":". Consecutive 0s can be abbreviated as "::". (E.g. 2001:2:3:4::5)</li> </ul>
Default Gateway (Static Only)	<ul style="list-style-type: none"> <li>• If you have the assigned Default Gateway IPv6 address by your ISP or network administrator, enter it in this data field.</li> <li>• IPv6 address consists of 8 hexadecimal digits divided with ":". Consecutive 0s can be abbreviated as "::". (E.g. 2001:2:3:4::5)</li> </ul>

Setting	Description
DNS Server Address	<ul style="list-style-type: none"> <li>• DNS server address is required in the following conditions.                             <ul style="list-style-type: none"> <li>• Transferring camera images by E-mail or FTP</li> <li>• Setting cameras by their host names on the Multi-Camera Setup page</li> <li>• Using the Viewnetcam.com service</li> </ul> </li> <li>• If you have the assigned DNS server IPv6 addresses by your ISP or network administrator, enter them in this data field. They usually have two addresses.</li> <li>• IPv6 address consists of 8 hexadecimal digits divided with ":". Consecutive 0s can be abbreviated as "::". (E.g. 2001:2:3:4::5)</li> </ul>
Max. Bandwidth Usage	<ul style="list-style-type: none"> <li>• The bandwidth can be restricted.</li> <li>• Select the maximum bandwidth usage from [Unlimited] to [0.1 Mbps].</li> <li>• This setting is valid in both IPv4/IPv6.</li> </ul> <p><b>Note</b></p> <p>Set the maximum bandwidth usage seeing the following file sizes. These are examples for a JPEG file with a standard image quality. File sizes may change depending on the image quality or how bright the object is.</p> <p>160 x 120 pixels: About 5 KB (40 Kbit)                      320 x 240 pixels: About 16 KB (128 Kbit)                      640 x 480 pixels: About 33 KB (264 Kbit)</p>
Connection Type	<ul style="list-style-type: none"> <li>• Select [Auto Negotiation] normally. If you cannot access the camera, see page 48 "The Top page is not displayed." in the Installation/Troubleshooting.</li> <li>• This setting is valid in both IPv4/IPv6.</li> </ul>

## 2.4 What is IPsec?

IPsec provides security for the transmission of sensitive information over unprotected networks such as the Internet. IPsec authenticates IP packets between participating IPsec devices.

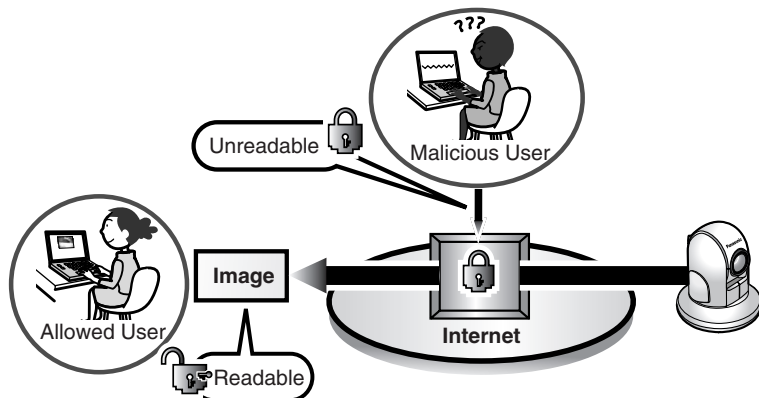

### Camera's IPsec Feature

The camera can use IPsec in both IPv4/IPv6. The camera supports the following IPsec feature.

Item	Supported Feature
IKEv1	Pre-shared Key Method Phase 1 mode : Main mode <sup>1</sup> Phase 2 mode : Quick mode Cipher Algorithm : DES-CBC, 3DES-CBC, AES-CBC (128, 192, 256 bits) Message-Digest Algorithm : HMAC-MD5, HMAC-SHA-1
IPsec	ESP (Encapsulating Security Payload) <sup>2</sup> Transport mode, Tunnel mode Cipher Algorithm :DES-CBC, 3DES-CBC, AES-CBC (128, 192, 256 bits) Message-Digest Algorithm :HMAC-MD5-96, HMAC-SHA-1-96

<sup>1</sup> The camera does not support aggressive mode.

<sup>2</sup> The camera does not support authentication header (AH).

## IPsec Mode Selection

Select transport mode or tunnel mode to access the camera.

### Transport Mode (IPv4 Only)

The image is encrypted in the whole way between the camera and your PC. In the environment of Windows XP Service Pack 1 or later, transport mode is available only in IPv4.

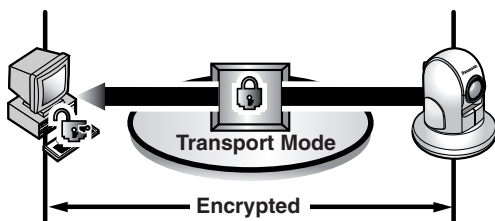

Prepare the following requirements.

Item	Supported Feature
PC	<p>Operating System : Windows XP Service Pack 1 or later                      Web Browser : Internet Explorer 6.0 or later                      ISP Service : Services for multiple global addresses (A global address must be set up on your PC.)</p> <p><b>Note</b>                      To use IPsec, you need to set up your operating system. See the Panasonic Network Camera support website at <a href="http://panasonic.co.jp/pcc/products/en/netwcam/">http://panasonic.co.jp/pcc/products/en/netwcam/</a> for the setup.</p>
Camera	<p>ISP Service : Services for multiple global addresses (A global address must be set up to the camera.)</p>

## Tunnel Mode (IPv4/IPv6)

An IPsec mode of operation where the entire IP packet including IP header is authenticated and encrypted. A new IP header is added (protecting the entire original packet). Both VPN clients and VPN gateways can use this mode.

### Note

The camera can be accessed only from the PCs under the VPN router. Other PCs cannot access the camera.

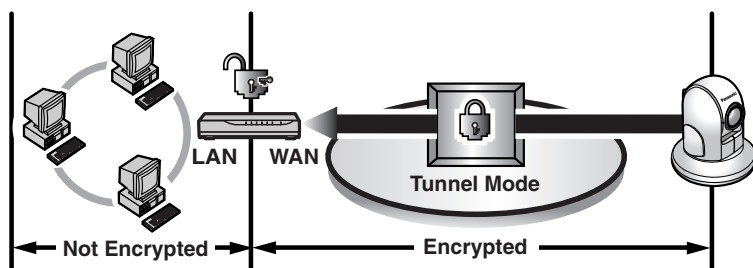

Prepare the following requirements.

Item	Supported Feature
PC	Operating System : Windows XP, Windows 2000, Windows Me, Windows 98SE (in IPv4) : Windows XP Service Pack 1 or later (in IPv6) Web Browser : Internet Explorer 6.0 or later
Router	ISP Service (in IPv4) : Static global address service (A global address must be set up to the WAN side of the router.) ISP Service (in IPv6) : "IPv4/IPv6 Dual-Stack" or "IPv6 over IPv4 Tunneling" service <b>Note</b> See the Panasonic Network Camera support website at <a href="http://panasonic.co.jp/pcc/products/en/netwkcam/">http://panasonic.co.jp/pcc/products/en/netwkcam/</a> for the recommended router.
Camera	ISP Service (in IPv4) : Services for multiple global addresses (A global address must be set up to the camera.) ISP Service (in IPv6) : "IPv4/IPv6 Dual-Stack" or "IPv6 over IPv4 Tunneling" service

## 2.5 Encrypt the Camera Image in Transport Mode

The camera can encrypt the image using IPsec transport mode.

### Note

If you use IPsec, refresh interval slows down.

1. Click [IPsec] on the Setup page.
2. Click **Camera** in the Transport column.
  - If you use transport mode in E-mail or FTP transfer, click **No.** in the Buffer/Transfer column.

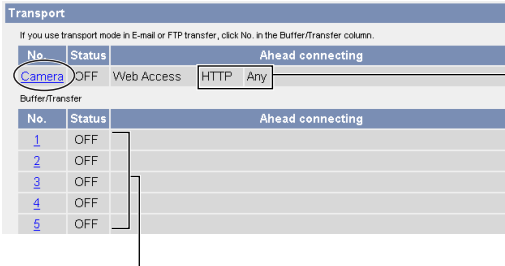

The display shows that the communication is in HTTP and any people can access the camera if they have the pre-shared key (see page 57).

Set up these settings to transfer images in transport mode (see page 111).

3. Enter each parameter in the data field.

Status	<input type="checkbox"/> ON
Pre-Shared Key (1 to 63 Characters)	<input type="text"/>
Retype Pre-Shared Key	<input type="text"/>

Save Cancel



Setting	Description
Status	<ul style="list-style-type: none"> <li>Check the box to use this encryption method.</li> </ul>
Pre-Shared Key	<ul style="list-style-type: none"> <li>It is the key to use in the authentication of communications. Enter the same pre-shared key as your PC.</li> <li>Enter ASCII characters for the host name (see page 150). But [Space], ["], ['], [&amp;], [&lt;] and [&gt;] are not available.</li> </ul> <p><b>Note</b></p> <p>If the pre-shared key leaks to a third party, it may lead to illegal access, private information leak or interference. To protect your security and privacy, pay attention to the following points.</p> <ul style="list-style-type: none"> <li>Make it known only to the specified people.</li> <li>Set it as many characters as possible.</li> <li>Change the password regularly.</li> </ul>

- Click [Save] when finished.
  - New settings are saved.
- Click [Cancel].
  - The IPsec page is displayed.
- Check [Use] in the IPsec column, check encoding strength, and click [Save].

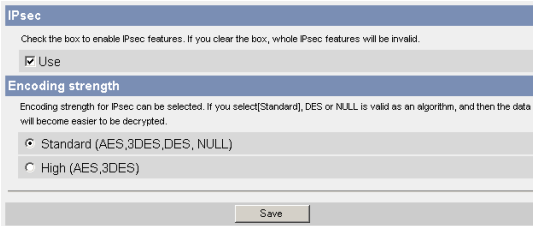

Setting	Description
IPsec	<ul style="list-style-type: none"> <li>Check the box to enable IPsec features. If you clear the box, whole IPsec features will be invalid.</li> </ul>
Encoding strength	<ul style="list-style-type: none"> <li>Encoding strength for IPsec can be selected. If you select [Standard], DES or NULL is valid as an algorithm, and then the data will become easier to be decrypted.</li> </ul>

7. Click [Restart].
8. Set up your PC as it fits to the requirements on page 54.
  - Set the FTP server or E-mail server to transfer images.
9. Access the camera (see page 13).
  - If you can access the camera, the IPsec setup is complete.

**Note**

- In IPsec communications, "IPsec" is displayed on the Top page or the Single Camera page.
- If you cannot communicate using IPsec, see 2.9 IPsec in the Troubleshooting section of the Installation/Troubleshooting.
- See the Panasonic Network Camera support website at <http://panasonic.co.jp/pcc/products/en/netwkcaml/> for the IPsec features.

## 2.6 Encrypt the Camera Image in Tunnel Mode

The camera can encrypt the image using IPsec tunnel mode.

### Note

- Do not set IPsec on the PCs under the VPN router. Communications may be blocked.
- If you use IPsec, refresh interval slows down.
- The camera can be accessed only from the PCs under the VPN router. Other PCs cannot access the camera.

1. Click [IPsec] on the Setup page.
2. Click **Add** in the Tunnel column.

Tunnel		
When IPsec setting is added, when link of "Add".Click the number, and edit the tunnel mode.		
No.	Status	Ahead connecting
<a href="#">Add</a>		

3. Enter each parameter in the data field.

Tunnel setting	
Status	<input checked="" type="checkbox"/> ON
Pre-Shared Key (1 to 63 Characters)	<input type="text"/>
Retype Pre-Shared Key	<input type="text"/>
Network address	<input type="text"/>
Router address	<input type="text"/>
<input type="button" value="Save"/> <input type="button" value="Cancel"/>	

Setting	Description
Status	<ul style="list-style-type: none"> <li>Check the box to use this encryption method.</li> </ul>
Pre-Shared Key	<ul style="list-style-type: none"> <li>It is the key to use in the authentication of communications. Enter the same pre-shared key as your VPN router.</li> <li>Enter ASCII characters for the host name (see page 150). But [Space], ["], ['], [&amp;], [&lt;] and [&gt;] are not available.</li> </ul> <p><b>Note</b></p> <p>If the pre-shared key leaks to a third party, it may lead to illegal access, private information leak or interference. To protect your security and privacy, pay attention to the following points.</p> <ul style="list-style-type: none"> <li>Make it known only to the specified people.</li> <li>Set it as many characters as possible.</li> <li>Change the password regularly.</li> </ul>
Network address	<ul style="list-style-type: none"> <li>Enter the destination network address.</li> <li>Enter "IP address/Prefix length" in the data field.</li> </ul>
Router address	<ul style="list-style-type: none"> <li>Enter the WAN IP address of the VPN router on a destination network.</li> </ul> <p><b>Note</b></p> <ul style="list-style-type: none"> <li>IPv6 link-local address is not available.</li> <li>The camera can be accessed only from the PCs under the VPN router. Other PCs cannot access the camera.</li> </ul>

- Click [Save] when finished.
  - New settings are saved.
- Click [Cancel].
  - The IPsec page is displayed.
- Check [Use] in the IPsec column, check encoding strength, and click [Save].

The screenshot shows a configuration window for IPsec. At the top, there is a blue header labeled 'IPsec'. Below it, a message reads: 'Check the box to enable IPsec features. If you clear the box, whole IPsec features will be invalid.' There is a checkbox labeled 'Use' which is checked. Below this is another blue header labeled 'Encoding strength'. A message reads: 'Encoding strength for IPsec can be selected. If you select(Standard), DES or NULL is valid as an algorithm, and then the data will become easier to be decrypted.' There are two radio button options: 'Standard (AES,3DES,DES, NULL)' which is selected, and 'High (AES,3DES)'. At the bottom of the window is a 'Save' button.

Setting	Description
IPsec	<ul style="list-style-type: none"> <li>Check the box to enable IPsec features. If you clear the box, whole IPsec features will be invalid.</li> </ul>
Encoding strength	<ul style="list-style-type: none"> <li>Encoding strength for IPsec can be selected. If you select [Standard], DES or NULL is valid as an algorithm, and then the data will become easier to be decrypted.</li> </ul>

7. Click [Restart].

8. Set up your VPN router as shown below.

- To use tunnel mode, you need to set up your VPN router.

IKE Items		Settings
Phase 1	Authentication Method	Pre-shared Key Method
	ID	Specifies by address.
	Mode	Main mode <sup>1</sup>
	Diffie-Hellman MODP Group	Specifies 1 or 2.
	Cipher Algorithm	Select from DES-CBC, 3DES-CBC or AES-CBC (128, 192, 256 bits). (Multiple selections are available.)
	Message-Digest Algorithm	HMAC-MD5, HMAC-SHA-1
	Lifetime	Specifies by 28800 s (Byte setting is not supported.)

IKE Items		Settings
Phase 2	Mode	Quick mode
	PFS	Specifies either of Off, D-H Group 1 or D-H Group 2.
	Cipher Algorithm	Select from DES-CBC, 3DES-CBC, AES-CBC (128, 192, 256 bits) or NULL. (Multiple selections are available.)
	Message-Digest Algorithm	HMAC-MD5-96, HMAC-SHA-1-96
	Lifetime	Specifies by 28800 s (Byte setting is not supported.)

\*1 The camera does not support aggressive mode.

- Set up the IPsec policy as the following.

Items	Settings
Protocol	ANY
Source Network	Network address and subnet mask on the LAN side of the VPN router
Source IP address	A global address on the WAN side of the VPN router
Destination Network	A global address of the camera
Destination IP address	A global address of the camera

**9.** Access the camera (see page 13).

- If you can access the camera, the IPsec setup is complete.

**Note**

- In IPsec communications, "IPsec" is displayed on the Top page or the Single Camera page.
- If you cannot communicate using IPsec, see 2.9 IPsec in the Troubleshooting section of the Installation/Troubleshooting.
- See the Panasonic Network Camera support website at <http://panasonic.co.jp/pcc/products/en/netwkcaml/> for the IPsec features.

## 2.7 Using UPnP™ (Universal Plug and Play)

UPnP™ can automatically configure your router to be accessed from the Internet. In order to use this feature, your router needs to support this feature and it must be enabled. Most router manufacturers disable this feature as the default setting. See [http://panasonic.co.jp/pcc/products/en/netwkcam/technic/rtr\\_setup/](http://panasonic.co.jp/pcc/products/en/netwkcam/technic/rtr_setup/) for details and see your router manual for how to enable UPnP™. After the UPnP™ is enabled on the router, set [Enable] for auto port forwarding.

### Note

The camera's UPnP™ does not support IPv6. Use this feature in IPv4.

1. Click [UPnP] on the Setup page.
2. Set up UPnP.

The screenshot shows a web interface for UPnP configuration. It has two main sections, each with a blue header and two radio button options: 'Enable' and 'Disable'.  
 - The first section is titled 'Auto Port Forwarding'. The 'Disable' radio button is selected.  
 - The second section is titled 'Display Shortcut Icon in My Network Places'. The 'Disable' radio button is selected.  
 - At the bottom right of the form is a 'Save' button.

Setting	Description
Auto Port Forwarding	<ul style="list-style-type: none"> <li>• If the network setting is [Static] or [DHCP], enabling auto port forwarding allows you to access the camera from the Internet.</li> </ul> <p><b>Note</b></p> <p>If the network setting is [Automatic Setup], enable [Allow Access from the Internet] on the Network page (see page 46).</p>
Display Shortcut Icon in My Network Places	<ul style="list-style-type: none"> <li>• Enabling it displays a shortcut to the camera in the My Network Places folder.</li> </ul> <p><b>Note</b></p> <p>If you use Windows XP or Windows Me, this feature is available. Enable UPnP™ Windows component before using this feature (see page 149).</p>

- 3.** Click [Save] when finished.
  - New settings are saved.
  - When finished, "Success!" is displayed.
- 4.** Click [Go to UPnP page].
  - The UPnP page is displayed.



## 2.8 Registering with the Viewnetcam.com service

Viewnetcam.com is a free service (dynamic DNS service) that allows you to assign an easy to remember name to the camera, similar to your favorite web site.

Viewnetcam.com also allows you to easily access the camera, even when your ISP changes the IP address. Panasonic Communications recommends you to register with it for the Internet access to the camera. See <http://www.viewnetcam.com> for details about the Viewnetcam.com service.

1. Click [Viewnetcam.com] on the Setup page.
2. Check [Enable].

- Clicking [Cancel] cancels your settings without saving changes.

Setting	Description
Enable	<ul style="list-style-type: none"> <li>• Check [Enable] to register with the Viewnetcam.com service. If you clear the box, the Viewnetcam.com service stops.</li> </ul>
Personal (Camera) URL	<ul style="list-style-type: none"> <li>• The camera's personal URL will be displayed after you register with the Viewnetcam.com service.</li> </ul>
Your Account Link	<ul style="list-style-type: none"> <li>• The URL is displayed to register with the Viewnetcam.com service. Clicking [Your Account Link] item name displays the Viewnetcam.com registration website.</li> </ul>

3. Click [Save] when finished.
  - New settings are saved.
  - When finished, "Success!" is displayed.
4. Click [Go to Viewnetcam.com page].
  - The Viewnetcam.com page is displayed.
5. Click [Your Account Link].
  - The Viewnetcam.com registration website is displayed.

**Note**

- When the Viewnetcam.com registration website is not displayed, confirm that the URL is displayed in the right column of the Your Account Link. If the URL is not displayed, follow the procedures below.
    1. Wait for a while, and click [Refresh] on the web browser.
    2. Confirm that your network (your PC and camera) is connected to the Internet.
  - Personal (Camera) URL is available after you registered with the Viewnetcam.com service.
  - If port forwarding is not enabled or your network is not connected to the Internet, the Viewnetcam.com service is not available.
- 6.** Register with the Viewnetcam.com service following the website.
- The Viewnetcam.com page is displayed.
- 7.** Access the camera with a registered URL from the Internet (see page 13).
- When the Top page is displayed, the Viewnetcam.com registration is complete.

**Note**

- It may take a maximum of 30 minutes for the registered URL to work.
- If "Expired" is displayed at the Personal (Camera) URL on the Viewnetcam.com page or at the Camera URL in the DDNS on the Status page, restart the camera. After that, confirm that your registered URL is displayed on their pages.

**Confirming the Internet access**

Due to the router specifications, the image may not be displayed even if you access the camera from your PC on the same LAN as the camera. In this case, access the camera following procedures.

- Accessing from the PC on another network (see page 13)
- Accessing from your cell phone (see page 39)

## 2.9 Setting Date and Time

The Date and Time page allows you to set date and time. Date and time are used for image buffer/transfer, operation time and time stamps on the buffered image.

### Note

Saving the date and time settings deletes all buffered images on the internal memory. The buffered images on the SD memory card are not deleted.

1. Click [Date and Time] on the Setup page.
2. Set each parameter.
  - Set [Automatic Time Adjustment] to synchronize the time automatically with an NTP server.

Time Setting			
Date	Month <input type="text" value="Jun"/>	Day <input type="text" value="10"/>	Year <input type="text" value="04"/>
Format	<input type="text" value="AM/PM"/>	<input type="text" value="24H"/>	
Time	Hour <input type="text" value="7"/>	Minute <input type="text" value="35"/>	<input type="text" value="PM"/>
Automatic Time Adjustment			
<input type="checkbox"/> Enable			
NTP Server Address or Host Name	<input type="text"/>		
Time Zone	<input type="text" value="GMT-05:00 Eastern Time"/>		
Adjust Clock for Daylight Saving Time			
<input type="checkbox"/> Enable			
Start Day:	Month <input type="text" value="Apr"/>	Weekday <input type="text" value="First Sunday"/>	Hour <input type="text" value="2"/> <input type="text" value="AM"/>
End Day:	Month <input type="text" value="Oct"/>	Weekday <input type="text" value="Last Sunday"/>	Hour <input type="text" value="2"/> <input type="text" value="AM"/>
		<input type="text" value="Save"/>	<input type="text" value="Cancel"/>

- Clicking [Cancel] cancels your settings without saving changes.

Setting	Description
Time Setting	<ul style="list-style-type: none"> <li>Select date and format (AM/PM or 24 H). These settings are used for image buffer/transfer, operation time and time stamps on the buffered image. But E-mail subject and file name by E-mail or FTP transfer uses only 24 h format.</li> </ul>
Automatic Time Adjustment	<ul style="list-style-type: none"> <li>NTP (Network Time Protocol) server synchronizes the camera's internal clock. It adjusts automatically every day. Check the box to enable it.</li> <li>Set the NTP server IP address. In IPv4, set 4 digits (0—255) and 3 periods such as "192.168.0.253". But "0.0.0.0" and "255.255.255.255" are not available. In IPv6, set 8 hexadecimal digits divided with ":". Consecutive 0s can be abbreviated as "::". Or set a host name (1—255 characters).</li> <li>Select your time zone.</li> </ul> <p><b>Note</b></p> <p>The camera will not synchronize to the NTP server if the time setting from the NTP server moves forward or backward more than 1 hour at a time. This is to protect the camera's time setting from fraudulent NTP server tampering, incorrect time information, etc.</p>
Adjust Clock for Daylight Saving Time	<ul style="list-style-type: none"> <li>During the daylight saving time, the internal clock is turned forward an hour. The clock will shift one hour forward at the set time on the Start Day, and move back one hour at the set time on the End Day. Check the box to enable it.</li> </ul> <p><b>Note</b></p> <p>An "s" is put between date and time of time stamp when enabling this feature. The time stamp will be attached to the transferred images by the Image Transfer feature.</p>

- Click [Save] when finished.
  - New settings are saved.
  - When finished, "Success!" is displayed.
- Click [Go to Date and Time page].
  - The Date and Time page is displayed.

**Note**

Date and time settings become incorrect depending on the length of power-on time or the internal temperature. Using the Automatic Time Adjustment is recommended.

## 2.10 Changing Camera Settings

The Camera page allows you to set the camera name, white balance, AC power source frequency, automatic focus range, mounting type, pan/tilt range, return to specified position, color night view, and vertical resolution settings.

1. Click [Camera] on the Setup page.
2. Set each parameter.

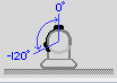
<b>Camera Name</b>		
Camera Name	NetworkCamera	
<b>White Balance</b>		
White Balance	Auto	
<b>AC Power Source Frequency</b>		
<input type="radio"/> 50Hz <input checked="" type="radio"/> 60Hz		
<b>Automatic Focus Range</b>		
Automatic Focus Range	Macro	
<b>Mounting type</b>		
<input checked="" type="radio"/> On the ceiling <input type="radio"/> On the table		
 		
<b>Pan Range</b>		
Minimum	Home Position	Maximum
-175 degrees	0 degrees	+175 degrees
<b>Tilt Range</b>		
Minimum	Home Position	Maximum
-120 degrees	-90 degrees	0 degrees
<b>Return to Specified Position</b>		
Time	Do not move	
Specified Position	Home Position	
<b>Color Night View</b>		
<input checked="" type="radio"/> Enable <input type="radio"/> Disable		
<b>Vertical Resolution (for 640 x 480 mode)</b>		
<input checked="" type="radio"/> 480 (Better for still images) <input type="radio"/> 240 (Better for motion images)		
<input type="button" value="Save"/> <input type="button" value="Cancel"/>		

- Clicking [Cancel] cancels your settings without saving changes.

Setting	Description
Camera Name	<ul style="list-style-type: none"> <li>• The camera name is displayed on the Single Camera page.</li> <li>• Enter ASCII characters (see page 150) or characters in each language (1—15 characters for a 1-byte character and 1—7 characters for a 2-byte character). But [Space], ["], ['], [&amp;], [&lt;], and [&gt;] are not available.</li> </ul>
White Balance	<p>Select from the following options.</p> <ul style="list-style-type: none"> <li>• Auto (default) — Automatic adjustment</li> <li>• Fixed Indoor — Electric bulb (2800 K)</li> <li>• Fixed Fluorescent (White) — White (3600 K)</li> <li>• Fixed Fluorescent (Daylight) — Daylight (4000 K)</li> <li>• Fixed Outdoor — Solar light (6000 K)</li> <li>• Hold — Setting [Hold] keeps the current white balance.</li> </ul> <p><b>Note</b></p> <p>White balance is also saved in the home position, alarm position and preset buttons.</p>
AC Power Source Frequency	<p>It can select Flicker Correction by power line frequency.</p> <ul style="list-style-type: none"> <li>• 60 Hz (default)</li> <li>• 50 Hz</li> </ul> <p>Select 60 Hz in the United States.</p>
Automatic Focus Range	<p>Set to "Macro" when viewing objects that are within 1 m (40 inches) of the camera. Set to "Normal" when viewing objects that are 1 m (40 inches) or further from the camera.</p> <ul style="list-style-type: none"> <li>• When positioning the camera in front of a window to view images on the other side of the window, set the Automatic Focus Range to "Normal".</li> </ul>
Mounting Type	<p>Set to match the installation method used to mount the camera.</p> <ul style="list-style-type: none"> <li>• When set to "On the ceiling", the available tilt range is 0 to +90 degrees.</li> <li>• When set to "On the table", the available tilt range is -120 to 0 degrees.</li> </ul>

Setting	Description
Pan Range <sup>1</sup>	<p>Select from the following options.</p> <ul style="list-style-type: none"> <li>• Minimum — Current settings, -175—+175</li> <li>• Home Position<sup>2</sup> — Current settings, -175—+175</li> <li>• Maximum — Current settings, -175—+175</li> </ul> <p>The values must be selected as minimum <math>\leq</math> home position <math>\leq</math> maximum.</p> <p><b>Note</b></p> <p>If you wrongly set the range, your privacy may be seen. Check the range after the setup.</p>
Tilt Range <sup>1</sup>	<p>Select from the following options.</p> <p><b>When the camera is mounted on a ceiling</b></p> <ul style="list-style-type: none"> <li>• Minimum — Current settings, 0—+90</li> <li>• Home Position<sup>2</sup> — Current settings, 0—+90</li> <li>• Maximum — Current settings, 0—+90</li> </ul> <p><b>When the camera is mounted on a table</b></p> <ul style="list-style-type: none"> <li>• Minimum — Current settings, -120—0</li> <li>• Home Position<sup>2</sup> — Current settings, -120—0</li> <li>• Maximum — Current settings, -120—0</li> </ul> <p>The values must be selected as minimum <math>\leq</math> home position <math>\leq</math> maximum.</p> <p><b>Note</b></p> <p>If you wrongly set the range, your privacy may be seen. Confirm the range after the setup.</p>
Return to Specified Position	<ul style="list-style-type: none"> <li>• If the camera is not operated during the specified period, the camera turns to the specified position.</li> </ul> <p><b>Note</b></p> <p>If you did not set any presets, the camera cannot turn to the preset position.</p>

Setting	Description
Color Night View	<ul style="list-style-type: none"> <li>• In the color night view mode, the camera image becomes brighter in a low illuminance. The camera image returns normal operation in a bright location.</li> <li>• In color night view mode, the following may be experienced:               <ul style="list-style-type: none"> <li>• Image refresh rate may slow down.</li> <li>• Images may blur when viewing moving objects or using Pan/Tilt/Zoom in low illuminance.</li> <li>• It may take a while to focus on some objects by auto focusing.</li> <li>• Images may not be displayed correctly on a TV.</li> </ul> </li> </ul> <p><b>Note</b></p> <p>In the color night view mode, the image may have white or colored circles around the object. This is not a problem, since it is a CCD sensor characteristic.</p>
Vertical Resolution (for 640 x 480 mode)	<p>When viewing motion images in 640 x 480 resolution, scan lines may appear when objects pass horizontally in front of the camera or when the camera pans horizontally. Set to "240" to remove the scan lines.</p>

<sup>1</sup> See page 73 for details about pan/tilt range settings.

<sup>2</sup> These home position settings are displayed as you set on page 28.

**3.** Click [Save] when finished.

- New settings are saved. If the home position is changed, the camera turns to the home position.
- When finished, "Success!" is displayed.

**4.** Click [Go to Camera page].



- The Camera page is displayed.

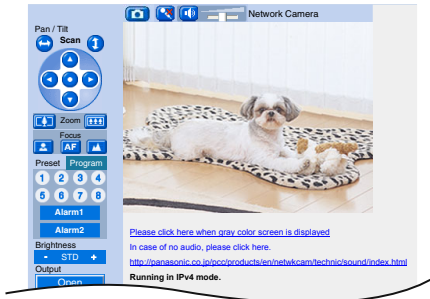

## Specifying Pan/Tilt Range

1. Access the camera (see page 13), and click [Single] at the top of the Top page.
2. Open another web browser, and display the Camera page (see page 69).
3. Align the Single Camera page and the Camera page side to side.



<b>Camera Name</b>		
Camera Name	NetworkCamera	
<b>White Balance</b>		
White Balance	Auto	
<b>AC Power Source Frequency</b>		
<input type="radio"/> 50Hz <input checked="" type="radio"/> 60Hz		
<b>Automatic Focus Range</b>		
Automatic Focus Range	Macro	
<b>Mounting type</b>		
<input type="radio"/> On the ceiling <input checked="" type="radio"/> On the table		
 		
<b>Pan Range</b>		
Minimum	Home Position	Maximum
-175 degrees	0 degrees	+175 degrees
<b>Tilt Range</b>		
Minimum	Home Position	Maximum
-120 degrees	-90 degrees	0 degrees
<b>Return to Specified Position</b>		
Time	Do not move	
Specified Position	Home Position	
<b>Color Night View</b>		
<input type="radio"/> Enable <input checked="" type="radio"/> Disable		
<b>Vertical Resolution (for 640 x 480 mode)</b>		
<input checked="" type="radio"/> 480 (Better for still images) <input type="radio"/> 240 (Better for motion images)		
		Save Cancel

4. Set the pan/tilt range.
  - Selecting [Current Settings] displays the current angle of the camera. Select each value while adjusting the pan/tilt on the Single Camera page.

### Note

The values must be selected as minimum  $\leq$  home position  $\leq$  maximum.

**When the camera is mounted on a table**

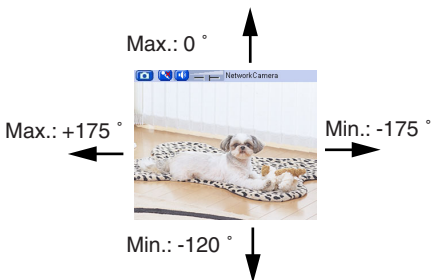

**When the camera is mounted on a ceiling**

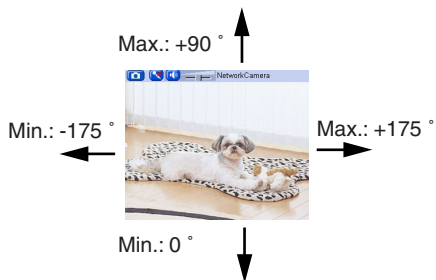

- 5.** Click [Save] on the Camera page.
  - New settings are saved. The camera turns to the home position.

## 2.11 Adjusting Audio

The Audio page allows you to adjust the microphone, the use of external speaker, microphone sensitivity and external speaker volume.

1. Click [Audio] on the Setup page.
2. Set each parameter.

The screenshot displays the Audio settings interface with the following sections and options:

- Output**: Radio buttons for  Enable and  Disable.
- Volume**: A dropdown menu set to **Standard**.
- PC Audio Input Timeout**: A dropdown menu set to **1 min**.
- Input**: Radio buttons for  Enable and  Disable.
- Camera Microphone Sensitivity**: A dropdown menu set to **Standard**.
- Mute during Pan/Tilt**: Radio buttons for  Enable and  Disable.

At the bottom of the form are two buttons: **Save** and **Cancel**.

- Clicking [Cancel] cancels your settings without saving changes.

Setting	Description
Output	<ul style="list-style-type: none"> <li>It controls audio output for external speaker connected to the camera.</li> </ul>
Volume	<ul style="list-style-type: none"> <li>It controls the volume to output to external speaker.</li> </ul>
PC Audio Input Timeout	<ul style="list-style-type: none"> <li>You can set the time to consecutively perceive the audio from your PC. (1—60 minutes)</li> </ul>
Input	<ul style="list-style-type: none"> <li>It controls audio input from the external microphone connected to the camera.</li> </ul>
Camera Microphone Sensitivity	<ul style="list-style-type: none"> <li>You can select the microphone sensitivity. Minimum: Decreased sensitivity Standard: Standard setting (default) Maximum: Enhanced sensitivity</li> </ul>
Mute during Pan/Tilt	<ul style="list-style-type: none"> <li>You can temporarily stop listening (audio input) when the camera pans or tilts.</li> </ul>

3. Click [Save] when finished.
  - New settings are saved.
  - When finished, "Success!" is displayed.
4. Click [Go to Audio page].
  - The Audio page is displayed.

## 2.12 Changing Authentication Setting and Administrator User Name and Password

The Security: Administrator page allows you to change authentication, administrator user name and password. The authentication window is displayed, and allows the registered users to access the camera.

### Note

- If you access the camera for the first time, the window to set administrator user name and password is displayed. Make a note of the user name and password so that you will not forget them.
- The user name and password should be secured at your own responsibility. Pay attention to the following points.
  - Set the user name and password as many characters as possible.
  - Change the password regularly.

### IMPORTANT

- It is important to limit access to the camera by use of a unique User Name and a secret Password. Because the camera is accessed through the Internet it is possible that the camera could be accessed by unknown individuals, including those who are commonly known as "hackers," to whom you do not want to allow access. The use of a unique User Name and a Password known only to you will help insure that only authorized individuals are given access to the camera. You have the option of proceeding without a User Name and Password, but it is strongly recommended that you utilize these protections.

1. Click [Administrator] on the Setup page.
2. Set each parameter.

General Authentication	
<input type="radio"/>	Permit access from guest users
<input checked="" type="radio"/>	Do not permit access from guest users
Administrator Authentication	
User Name (6 to 15 Characters)	<input type="text"/>
Password (6 to 15 Characters)	<input type="text"/>
Retype Password	<input type="text"/>
<input type="button" value="Save"/> <input type="button" value="Cancel"/>	

- Clicking [Cancel] cancels your settings without saving changes.

Setting	Description
<p>General Authentication</p>	<p>Authentication has 2 phases.</p> <ul style="list-style-type: none"> <li>If you set [Permit access from guest users], the camera does not display the authentication window in camera access. All guest users can view the image without user name and password.</li> </ul> <p><b>Note</b></p> <p>If you set [Permit access from guest users], [Login] is displayed at the top of the page. After you log in as an administrator (see page 80), you can access the Setup page and the Maintenance page.</p>  <ul style="list-style-type: none"> <li>If you set [Do not permit access from guest users], the camera displays authentication window in camera access. Users must enter the user name and password.</li> </ul>
<p>User Name/ Password</p>	<ul style="list-style-type: none"> <li>User Name (6 to 15 characters): Enter the user name.</li> <li>Password (6 to 15 characters): Enter the password.</li> </ul> <p><b>Note</b></p> <p>The password must be different from the user name.</p> <ul style="list-style-type: none"> <li>Retype Password: Reenter the password.</li> <li>Enter ASCII characters (see page 150). But [Space], ["], ['], [&amp;], [&lt;], [&gt;] and [:] are not available.</li> </ul>

**Note**

- When setting [General Authentication], set the user name and password.
  - When users other than an administrator are accessing the camera, [Setup] and [Maintenance] tab will not be displayed.
  - The user name and password are case sensitive.
- 3.** Click [Save] when finished.
- New settings are saved.
  - When finished, "Success!" is displayed.

4. Click [Go to Security: Administrator page].
  - The Security: Administrator page is displayed.

**Note**

- When the user name and password have been changed, the camera displays an authentication window. Enter the user name and password, and click [OK].

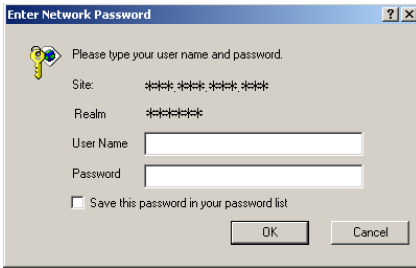

**Administrator/General Users/Guest Users**

The camera has 3 user levels (administrator, general users and guest users).

Items	Administrator	General Users	Guest Users
User Name and Password	Required	Required	Not Required
Number of Users	1	50	—
Accessible Pages	All Pages	Pages Except For Setup and Maintenance page	Pages Except For Setup and Maintenance page
Access Level	All Operations	Access level can be set for each general user (see page 81).	Access level can be set for guest users (see page 81).

**Note**

Guest users mean unregistered users. Set [Permit access from guest users] on the Security: Administrator page (see page 77).

## 2.13 Logging in to the Camera

If you set [Permit access from guest users] on the Security: Administrator page, [Login] is displayed at the top of the page. After you log in as an administrator, you can access the Setup page and the Maintenance page.

1. Click [Login] at the top of the page.



2. Check the login mode, and click [Login].

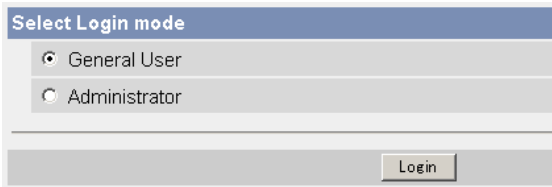

### Note

The authentication window is displayed. Enter the user name and password.

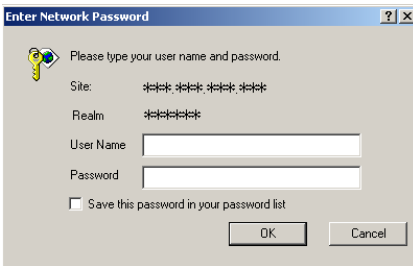

3. Enter a valid user name and password according to the Login mode selected in step 2, and click [OK] to log in to the camera.



## 2.14 Creating, Modifying or Deleting General Users

The General User page allows you to create, modify or delete general users. Up to 50 general users can be registered. The access level is set for each general user. If you set [Permit access from guest users] on the Security: Administrator page, the access level can be set for guest users.

### Note

- For general users, the Setup and Maintenance tabs are not displayed.

1. Click [General Users] on the Setup page.

2. If you create a general user, click [Create].

- When setting [Do not permit access from guest users]
- When setting [Permit access from guest users]

The screenshot shows a web interface titled "User ID List (Max. 50 Users)". It features a table with one row containing the text "Unregistered". To the right of the table are three buttons: "Create", "Modify", and "Delete".

The screenshot shows a web interface titled "User ID List (Max. 50 Users)". It features a table with one row containing the text "Guest User". To the right of the table are three buttons: "Create", "Modify", and "Delete".

- If you change the settings of general users or guest users, select their name and click [Modify]. The modification page is displayed.
- If you delete a general user, select the name and click [Delete]. The confirmation page is displayed.

3. Set each parameter.

- Settings for a general user
- Settings for guest users

The screenshot shows two stacked configuration forms. The top form is titled "Input User Name and Password" and contains three input fields: "User Name (6 to 15 Characters)", "Password (6 to 15 Characters)", and "Retype Password". The bottom form is titled "Access Level" and contains a dropdown menu for "Limit time of Continuous Motion JPEG" (set to "Not permitted"), a dropdown for "Refresh Interval" (set to "3 s"), and a list of checkboxes for various controls: Pan / Tilt Control, Zoom Control, Focus Control, Preset Control, Click to Center Control, Brightness Control, External Output Control, Change Refresh Interval, Change Resolution, Change Quality, Capture Image Button, Listen, Talk, View Multi-Camera page, and View Buffered Image page. "Save" and "Cancel" buttons are at the bottom.

The screenshot shows the "Access Level" configuration form. It features a dropdown menu for "Limit time of Continuous Motion JPEG" (set to "Not permitted"), a dropdown for "Refresh Interval" (set to "3 s"), and a list of checkboxes for various controls: Pan / Tilt Control, Zoom Control, Focus Control, Preset Control, Click to Center Control, Brightness Control, External Output Control, Change Refresh Interval, Change Resolution, Change Quality, Capture Image Button, Listen, Talk, View Multi-Camera page, and View Buffered Image page. "Save" and "Cancel" buttons are at the bottom.

- Clicking [Cancel] takes you back to the previous page without saving changes.

Setting	Description
User ID List	<ul style="list-style-type: none"> <li>Up to 50 general users can be registered.</li> <li>The list is used to modify or delete general user settings.</li> </ul>
User Name/ Password	<ul style="list-style-type: none"> <li>User Name (6 to 15 characters): Enter the user name.</li> <li>Password (6 to 15 characters): Enter the password.</li> </ul> <p><b>Note</b></p> <ul style="list-style-type: none"> <li>The password must be different from the user name.</li> <li>Retype Password: Reenter the password.</li> <li>Enter ASCII characters (see page 150). But [Space], ["], ['], [&amp;], [&lt;], [&gt;] and [:] are not available.</li> </ul>
Access Level	<p>Access level is set for each general user. Check the feature to enable.</p> <ul style="list-style-type: none"> <li>In the limit time of continuous Motion JPEG, set the time to change the video (Motion JPEG) to still images for each user. (Not permitted, Unlimited, 10 seconds—60 minutes) In the refresh interval, set the refresh interval after the video changes to still images. (3—60 seconds)</li> <li>See each page for the following features. <ul style="list-style-type: none"> <li>Pan/Tilt Control (see page 24)</li> <li>Zoom Control (see page 25)</li> <li>Focus Control (see page 26)</li> <li>Preset Control (see page 23)</li> <li>Click to Center Control (see page 21)</li> <li>Brightness Control (see page 23)</li> <li>External Output Control (see page 23)</li> <li>Change Refresh Interval (see page 23)</li> <li>Change Resolution (see page 23)</li> <li>Change Quality (see page 23)</li> <li>Capture Image Button (see page 22)</li> <li>Listen (see page 32)</li> <li>Talk (see page 32)</li> <li>View Multi-Camera page (see page 34)</li> <li>View Buffered Image page (see page 36)</li> </ul> </li> </ul>

- Click [Save] when finished.
  - New settings are saved.
  - When finished, "Success!" is displayed.

5. Click [Go to General User page].

## 2.15 Changing Initial Settings on the Single Camera page or the Multi-Camera page

The Image Display page allows you to change initial settings (display settings when a user accesses the camera) of image resolution, image quality and refresh interval. You can display a time stamp on the image. The initial language can be selected from eight languages. The banner can be displayed for administrator or general users or both.

1. Click [Image Display] at the top of the page.
2. Set each parameter.

Single Camera	
Image Resolution	320x240
Image Quality	Standard
Refresh Interval	Motion

Multi-Camera	
Image Resolution	320x240
Image Quality	Standard
Refresh Interval	Motion

Time stamp setting	
Time stamp	Not used

Language	
Language	English

Banner Display	
Administrator	<input checked="" type="checkbox"/> Display
General User	<input checked="" type="checkbox"/> Display

- Clicking [Cancel] cancels your settings without saving changes.

Setting	Description
Image Resolution	<ul style="list-style-type: none"> <li>Select the image resolution. 640 x 480 pixels (Only for the Single Camera page) 320 x 240 pixels (default) 160 x 120 pixels (Only for the Multi-Camera page)</li> </ul>
Image Quality	<ul style="list-style-type: none"> <li>Select the image quality. [Favor Clarity] optimizes for good quality. [Standard] offers standard quality. [Favor Motion] optimizes for enhanced motion.</li> </ul>
Refresh Interval	<ul style="list-style-type: none"> <li>Select a refresh interval. (Motion—60-second interval)</li> </ul>
Time stamp setting	<ul style="list-style-type: none"> <li>You can display a time stamp on the upper left side of the image. Select from [Not used], [AM/PM format] or [24H format].</li> </ul> <p><b>Note</b></p> <p>If you enable this feature, the time is also stamped on the buffered image.</p>
Language	<ul style="list-style-type: none"> <li>Select the initial language from English, French, German, Italian, Spanish, Russian, Simplified Chinese or Japanese. The selected language is displayed as the initial language on the Top, Single Camera, Multi-Camera and Buffered Image pages. If you select English or Japanese, all pages can be changed. But if you select other language, the Setup, Maintenance and Support pages are displayed only in English.</li> </ul>
Banner Display	<ul style="list-style-type: none"> <li>When the camera accesses the Internet, the banner displays product information about cameras or announcements about the latest firmware, etc. from Panasonic. Checking [Display] for Administrator is particularly recommended.</li> <li>When checked, the banner is displayed for administrator or general users or both.</li> <li>The banner is displayed only on the Single Camera page (see page 17).</li> </ul>

- Click [Save] when finished.
  - New settings are saved.
  - When finished, "Success!" is displayed.

- 4.** Click [Go to Image Display page].
  - The Image Display page is displayed.

## 2.16 Configuring Multiple Cameras

The Multi-Camera Setup page allows you to configure the camera IP addresses and camera names to view multiple images on the Multi-Camera page. These configurations are required to use the Multi-Camera page. Up to 12 cameras can be configured.

1. Click [Multi-Camera] on the Setup page.
2. Click [Add].

No.	Display	IP Address or Host Name	Port No.	Camera Name
<a href="#">Add</a>				

### Note

- If you click the camera number, the modification page is displayed. The camera setting can be modified or deleted on it.
- If you configured multiple cameras, you can change the camera number. Select the number, and click [Move].

Change Camera Order		
From No.	<input type="text" value="1"/>	To No.
	<input type="text" value="1"/>	<input type="button" value="Move"/>

3. Set each parameter.

Add Camera	
Display	<input checked="" type="checkbox"/> On
IP Address or Host Name	<input type="text"/>
Port No. (1 to 65535)	<input type="text"/>
Camera Name (1 to 15 characters)	<input type="text"/>
<input type="button" value="Save"/> <input type="button" value="Cancel"/>	

- Clicking [Cancel] cancels your settings without saving changes.

### Note

If the cameras will be accessed from the Internet, be sure to use the global IP address. In this situation, local IP addresses such as 192.168. x.x cannot be used.

Setting	Description
Display	<ul style="list-style-type: none"> <li>Check the box to enable the camera.</li> </ul>
IP Address <sup>*1</sup> or Host Name <sup>*2</sup>	<ul style="list-style-type: none"> <li>Set the IP address or the host name to enable the camera.</li> </ul>
Port No.	<ul style="list-style-type: none"> <li>Set the port number (1—65535).</li> </ul>
Camera Name <sup>*3</sup>	<ul style="list-style-type: none"> <li>This camera name is displayed only on the Multi-Camera page.</li> </ul>

<sup>\*1</sup> In IPv4, set 4 digits (0—255) and 3 periods such as "192.168.0.253". But "0.0.0.0" and "255.255.255.255" are not available.

In IPv6, set the host name.

<sup>\*2</sup> Enter ASCII characters for the host name (see page 150). But [Space], ["], ['], [#], [&], [%], [=], [+], [?], [<] and [>] are not available.

Enter 1—255 characters.

<sup>\*3</sup> Enter ASCII characters (see page 150) or characters in each language (1—15 characters for a 1-byte character and 1—7 characters for a 2-byte character). But [Space], ["], ['], [#], [&], [%], [=], [+], [?], [:], [<], and [>] are not available.

### **Note**

- Set the local IP address and port number for the camera on the same LAN.
- If the cameras will be accessed from the Internet, be sure to use the global IP address. In this situation, local IP addresses such as 192.168. x.x cannot be used.

#### **4.** Click [Save] when finished.

- New settings are saved.
- The Multi-Camera Setup page is displayed.



## 2.17 Format the SD memory card

Before you record the camera image, you need to format the SD memory card.

### Note

- You can confirm the SD memory capacity on the Status page (see page 118).
- Insert the SD memory card (see page 36 of the Installation/Troubleshooting).
  - Click [Buffer/Transfer] on the Setup page.
  - Click [Format].

Trigger												
No	Status	Trigger	Sun	Mon	Tue	Wed	Thu	Fri	Sat	Active Time of Trigger	Transfer Method	Notify
1	OFF	Timer	X	X	X	X	X	X	X	Always	No Transfer, No Memory Overwrite	-
2	OFF	Timer	X	X	X	X	X	X	X	Always	No Transfer, No Memory Overwrite	-
3	OFF	Timer	X	X	X	X	X	X	X	Always	No Transfer, No Memory Overwrite	-
4	OFF	Timer	X	X	X	X	X	X	X	Always	No Transfer, No Memory Overwrite	-
5	OFF	Timer	X	X	X	X	X	X	X	Always	No Transfer, No Memory Overwrite	-

SD memory card	
To format the SD memory card or stop SD recording, click the desired button below.	
Format	SD video recording stop

- Click [OK] on the confirmation window.
  - Format is complete.
- Click [Go to Image Buffer/Transfer page].
  - The Image Buffer/Transfer page is displayed.

## 2.18 Stop the SD Memory Recording

After you stop the SD memory recording, remove the SD memory card.

### Note

- You can confirm the SD memory capacity on the Status page (see page 118).
- Click [Buffer/Transfer] on the Setup page.
  - Click [SD video recording stop].

Trigger												
No.	Status	Trigger	Sun	Mon	Tue	Wed	Thu	Fri	Sat	Active Time of Trigger	Transfer Method	Notify
1	OFF	Timer	X	X	X	X	X	X	X	Always	No Transfer, No Memory Overwrite	-
2	OFF	Timer	X	X	X	X	X	X	X	Always	No Transfer, No Memory Overwrite	-
3	OFF	Timer	X	X	X	X	X	X	X	Always	No Transfer, No Memory Overwrite	-
4	OFF	Timer	X	X	X	X	X	X	X	Always	No Transfer, No Memory Overwrite	-
5	OFF	Timer	X	X	X	X	X	X	X	Always	No Transfer, No Memory Overwrite	-

SD memory card	
To format the SD memory card or stop SD recording, click the desired button below.	
Format	SD video recording stop

- Click [OK] on the confirmation window.
  - The SD memory recording is stopped.
- Click [Go to Image Buffer/Transfer page].
  - The Image Buffer/Transfer page is displayed.

### Note

- If the camera is restarted (see page 119), the SD memory recording starts again.
- If you remove the SD memory card and insert it again, the SD memory recording starts again (see page 36 of the Installation/Troubleshooting).
- Ensure that recording has been stopped, before removing the SD memory card. If the SD memory card is removed while recording, the image file will most likely become unreadable. In this case, format the SD memory card again. (Files will be deleted.)

## 2.19 Buffering or Transferring Images by Timer

The Image Buffer/Transfer page allows you to enable image buffer/transfer by E-mail or FTP.

### Note

If you are recording images to the SD memory card, refresh interval slows down.

1. Click [Buffer/Transfer] on the Setup page.
2. Click [No.] to enable buffer/transfer.

Trigger												
No.	Status	Trigger	Sun	Mon	Tue	Wed	Thu	Fri	Sat	Active Time of Trigger	Transfer Method	Notify
1	OFF	Timer	X	X	X	X	X	X	X	Always	No Transfer, No Memory Overwrite	-
2	OFF	Timer	X	X	X	X	X	X	X	Always	No Transfer, No Memory Overwrite	-
3	OFF	Timer	X	X	X	X	X	X	X	Always	No Transfer, No Memory Overwrite	-
4	OFF	Timer	X	X	X	X	X	X	X	Always	No Transfer, No Memory Overwrite	-
5	OFF	Timer	X	X	X	X	X	X	X	Always	No Transfer, No Memory Overwrite	-

3. Check [Enable Image Buffer/Transfer], select [Timer] for trigger, and click [Next>].

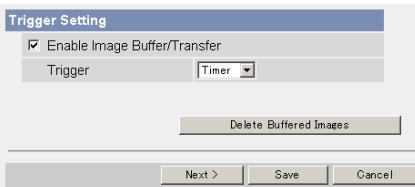

### Note

If you click [Save], all buffered images on the SD memory card are deleted.

- Click [Delete Buffered Images] to delete this buffered images.
- Click [Save] to save the settings.
- Clicking [Cancel] takes you back to the Image Buffer/Transfer page without saving changes.

Setting	Description
Enable Image Buffer/Transfer	<ul style="list-style-type: none"> <li>Check the box to enable the buffer/transfer. Clear the box to disable it.</li> </ul>
Trigger	<ul style="list-style-type: none"> <li>Selecting [Timer] enables the camera to buffer/transfer the image by timer.</li> <li>Selecting [Alarm 1 or 2] enables the camera to buffer/transfer the image by alarm signal.</li> </ul>

**4.** Set the time, and click [Next>].

**Note**

The timer works by an internal clock. Set the date and time before using timer buffer/transfer (see page 67).

- Clicking [<Back] takes you back to the previous page.
- Clicking [Cancel] takes you back to the Image Buffer/Transfer page without saving changes.

Setting	Description
A day of the week	<ul style="list-style-type: none"> <li>Check the box to enable the day. Clear the box to disable it.</li> </ul>
Active Time of Trigger	<ul style="list-style-type: none"> <li>Select the [Always] option when you do not specify the time period. If you specify the time period, select the time period option and set the time period.</li> </ul>

**5.** Set the image settings, and click [Next>].

- Clicking [<Back] takes you back to the previous page.
- Clicking [Cancel] takes you back to the Image Buffer/Transfer page without saving changes.

Setting	Description
Image Resolution	<ul style="list-style-type: none"> <li>Select image resolution (640 x 480, 320 x 240 (default) or 160 x 120 pixels) to buffer or transfer.</li> </ul>
Image Quality	<ul style="list-style-type: none"> <li>Select the image quality. <ul style="list-style-type: none"> <li>[Favor Clarity] optimizes for good quality.</li> <li>[Standard] offers standard quality.</li> <li>[Favor Motion] optimizes for enhanced motion.</li> <li>[Mobile Phone] is for a transfer to a cell phone.</li> </ul> </li> </ul> <p><b>Note</b> 640 x 480 pixels cannot be set for a transfer to a cell phone.</p>

**6.** Set the image buffer frequencies, and click [Next>].

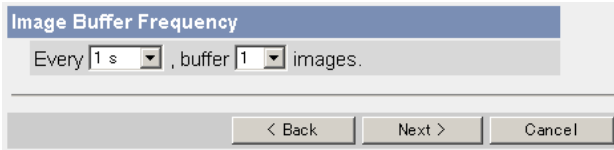

**Note**

Due to the network environment, object, number of accesses, enabling IPsec, SD memory recording, the camera may not record the numbers of images as you set. In this case, set the image buffer frequencies longer.

- Clicking [<Back] takes you back to the previous page.
- Clicking [Cancel] takes you back to the Image Buffer/Transfer page without saving changes.

Setting	Description
Image Buffer Frequency	<ul style="list-style-type: none"> <li>Select the image buffer frequency to buffer or transfer the image. (1 image per hour—30 images per second)</li> </ul>

7. Select the transfer method, and click [Next>].

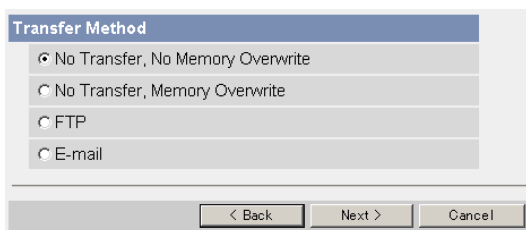

- Clicking [<Back] takes you back to the previous page.
- Clicking [Cancel] takes you back to the Image Buffer/Transfer page without saving changes.

**Note**

If you transfer image by E-mail or FTP, confirm that the default gateway and DNS server addresses are assigned correctly (see page 44 and page 49).

Setting	Description
No Transfer, No Memory Overwrite	• If the internal memory or the SD memory card is full, the camera stops the buffer.
No Transfer, Memory Overwrite	• If the internal memory or the SD memory card is full, the camera deletes the old images, and continues to buffer the image.
FTP	• The camera transfers the image to an FTP server (see page 95).
E-mail	• The camera transfers the image by E-mail (see page 97).

### When you set [FTP] for Transfer Method

Select [FTP], and click [Next>]. The following page is displayed.

FTP	
Server IP Address or Host Name	<input type="text"/>
Port No. (Usually Use 21)	<input type="text" value="21"/>
Login ID (0 to 63 Characters)	<input type="text"/>
Password (0 to 63 Characters)	<input type="text"/>
Login Timing	<input type="text" value="Every Time"/>
Upload File Name (1 to 234 Characters)	<input type="text"/>
Overwrite setting	<input type="text" value="Overwrite File"/>
Data Transfer Method	<input type="text" value="Passive Mode"/>

- Clicking [**<Back**] takes you back to the previous page.
- Clicking [**Cancel**] takes you back to the Image Buffer/Transfer page without saving changes.

Setting	Description
Server IP Address or Host Name <sup>1</sup>	<ul style="list-style-type: none"> <li>If you set the server IP address, set 4 digits (0—255) and 3 periods such as "192.168.0.253". But "0.0.0.0" and "255.255.255.255" are not available. Or set a host name (1—255 characters).</li> <li>You can set IPv6 address.</li> </ul>
Port No.	<ul style="list-style-type: none"> <li>Enter the number (1—65535). Usually set to 21.</li> </ul>
Login ID <sup>2</sup>	<ul style="list-style-type: none"> <li>If your ISP requires a login ID, set it (0—63 characters).</li> </ul>
Password <sup>2</sup>	<ul style="list-style-type: none"> <li>If your ISP requires a password, set it (0—63 characters).</li> </ul>
Login Timing	<ul style="list-style-type: none"> <li>Select the login timing to an FTP server. If you set [One Time] during 1-minute transfer, the camera logs in to the server only once, and can reduce the time to log in or log out.</li> </ul>
Upload File Name <sup>1</sup>	<ul style="list-style-type: none"> <li>Set the file name to save on an FTP server. Enter 1—234 characters. Entering "\" creates directories for a file. (E.g. NetworkCamera\image.jpg)</li> </ul>
Overwrite Setting	<ul style="list-style-type: none"> <li>Selecting [Overwrite File] saves and overwrites the image on the server. Selecting [Save as New File with Time Stamp] saves the image attaching time stamps on the file name, and the images are not overwritten.</li> </ul>
Data Transfer Method	<ul style="list-style-type: none"> <li>Select [Passive Mode] normally. If FTP does not work, select [Active Mode] and check the operation.</li> </ul>

<sup>1</sup> But [Space], ["], ['], [&], [<] and [>] are not available.

<sup>2</sup> But ["] is not available.



## When you set [E-mail] for Transfer Method

Select [E-mail], and click [Next>]. The following page is displayed.

E-mail Transfer	
SMTP Server IP Address or Host Name	<input type="text"/>
Port No. (Usually Use 25)	25 <input type="text"/>
POP3 Server IP Address or Host Name	<input type="text"/>
Port No. (Usually Use 110)	110 <input type="text"/>
Login ID (0 to 63 Characters)	<input type="text"/>
Password (0 to 63 Characters)	<input type="text"/>
Reply E-mail Address	<input type="text"/>
Destination E-mail Address 1	<input type="text"/>
Destination E-mail Address 2	<input type="text"/>
Destination E-mail Address 3	<input type="text"/>
Subject (Up to 44 Characters)	<input type="text"/>
Text (Up to 63 Characters)	<input type="text"/>
<input type="button" value=" &lt; Back"/> <input type="button" value=" Save"/> <input type="button" value=" Cancel"/>	

- Clicking [<Back] takes you back to the previous page.
- Clicking [Cancel] takes you back to the Image Buffer/Transfer page without saving changes.

### **Note**

The camera works only with an SMTP (Simple Mail Transfer Protocol) server. It does not work with mail servers like "Hotmail®" using a web browser.

Setting	Description
SMTP Server IP Address or Host Name <sup>1</sup>	<ul style="list-style-type: none"> <li>If you set the server IP address, set 4 digits (0—255) and 3 periods such as "192.168.0.253". But "0.0.0.0" and "255.255.255.255" are not available. Or set a host name (1—255 characters).</li> <li>You can set IPv6 address.</li> </ul>
Port No.	<ul style="list-style-type: none"> <li>Enter the number (1—65535). Usually set to 25.</li> </ul>
POP3 Server IP Address or Host Name <sup>1</sup>	<ul style="list-style-type: none"> <li>If you set the server IP address, set 4 digits (0—255) and 3 periods such as "192.168.0.253". But "0.0.0.0" and "255.255.255.255" are not available. Or set a host name (1—255 characters).</li> <li>You can set IPv6 address.</li> </ul>
Port No.	<ul style="list-style-type: none"> <li>Enter the number (1—65535). Usually set to 110.</li> </ul>
Login ID <sup>2</sup>	<ul style="list-style-type: none"> <li>If your ISP requires a login ID to log in to a POP3 server, set it (0—63 characters).</li> </ul>
Password <sup>2</sup>	<ul style="list-style-type: none"> <li>If your ISP requires a password to log in to a POP3 server, set it (0—63 characters).</li> </ul>
Reply E-mail Address <sup>2</sup>	<ul style="list-style-type: none"> <li>Set the sender's E-mail address. We recommend you to set the administrator's E-mail address.</li> </ul>
Destination E-mail Address <sup>2</sup> 1—3	<ul style="list-style-type: none"> <li>Set the destination E-mail address (up to 3).</li> </ul>
Subject <sup>2</sup>	<ul style="list-style-type: none"> <li>Enter a subject with ASCII characters (see page 150) or characters in each language (0—44 characters for a 1-byte character and 0—22 characters for a 2-byte character).</li> </ul>
Text	<ul style="list-style-type: none"> <li>Enter text with ASCII characters (see page 150) or characters in each language (0—63 characters for a 1-byte character and 0—31 characters for a 2-byte character). But [""] and [end-of-line] key are not available.</li> </ul>

<sup>1</sup> But [Space], ["], ['], [&], [<] and [>] are not available.

<sup>2</sup> But [""] is not available.

8. Confirm the settings, and click [Save].
  - New settings are saved.
  - When finished, "Success!" is displayed.
9. Click [Go to Image Buffer/Transfer page].
  - The Image Buffer/Transfer page is displayed.

**Note**

- If you click [Save] on the Image Buffer/Transfer page, all buffered images on the SD memory card are deleted.
- If you are buffering images on the internal memory, the following operations also delete all buffered images.
  - Turning off the camera.
  - Saving the Date and Time page.
  - Restarting, updating firmware or resetting the camera to factory default.

## 2.20 Buffering or Transferring Images by Alarm Signal

The Image Buffer/Transfer page allows you to enable image buffer/transfer by E-mail or FTP.

### Note

If you are recording images to the SD memory card, refresh interval slows down.

1. Click [Buffer/Transfer] on the Setup page.
2. Click [No.] to enable buffer/transfer.

Trigger												
No.	Status	Trigger	Sun	Mon	Tue	Wed	Thu	Fri	Sat	Active Time of Trigger	Transfer Method	Notify
1	OFF	Timer	X	X	X	X	X	X	X	Always	No Transfer, No Memory Overwrite	-
2	OFF	Timer	X	X	X	X	X	X	X	Always	No Transfer, No Memory Overwrite	-
3	OFF	Timer	X	X	X	X	X	X	X	Always	No Transfer, No Memory Overwrite	-
4	OFF	Timer	X	X	X	X	X	X	X	Always	No Transfer, No Memory Overwrite	-
5	OFF	Timer	X	X	X	X	X	X	X	Always	No Transfer, No Memory Overwrite	-

3. Check [Enable Image Buffer/Transfer], select [Alarm 1 or 2] for trigger, select [Rising: GND to Open (High).] or [Falling: Open (High) to GND.] and click [Next>].

**Trigger Setting**

Enable Image Buffer/Transfer

Trigger: Alarm 1

Alarm enable condition: Rising: GND to Open (High).

Delete Buffered Images

---

Next >
Save
Cancel

### Note

If you click [Save], all buffered images on the SD memory card are deleted.

- Click [Delete Buffered Images] to delete this buffered images.
- Click [Save] to save the settings.
- Clicking [Cancel] takes you back to the Image Buffer/Transfer page without saving changes.

Setting	Description
Enable Image Buffer/Transfer	<ul style="list-style-type: none"> <li>Check the box to enable the buffer/transfer. Clear the box to disable it.</li> </ul>
Trigger	<ul style="list-style-type: none"> <li>Selecting [Timer] enables the camera to buffer/transfer the image by timer.</li> <li>Selecting [Alarm 1 or 2] enables the camera to buffer/transfer the image by alarm signal.</li> </ul>
Alarm enable condition	<ul style="list-style-type: none"> <li>Select [Rising: GND to Open (High).] or [Falling: Open (High) to GND.]. [Rising: GND to Open (High).] is the state that GND pin and pin 1 or pin 2 is left open. [Falling: Open (High) to GND.] is the state that GND pin and pin 1 or pin 2 is short-circuited. (see page 128)</li> </ul>

**4.** Set the time, and click [Next>].

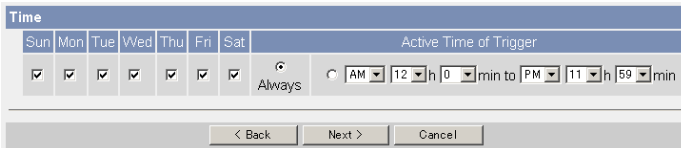

**Note**

The timer works by an internal clock. Set the date and time before using timer buffer/transfer (see page 67).

- Clicking [<Back] takes you back to the previous page.
- Clicking [Cancel] takes you back to the Image Buffer/Transfer page without saving changes.

Setting	Description
A day of the week	<ul style="list-style-type: none"> <li>Check the box to enable the day. Clear the box to disable it.</li> </ul>
Active Time of Trigger	<ul style="list-style-type: none"> <li>Select the [Always] option when you do not specify the time period. If you specify the time period, select the time period option and set the time period.</li> </ul>

5. Set the Lens Position When Triggered setting, and click [Next>].

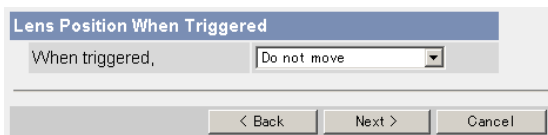

**Note**

If you enable the Lens Position When Triggered setting, buffer/transfer starts after the camera turns to the alarm position.

- Clicking [<Back] takes you back to the previous page.
- Clicking [Cancel] takes you back to the Image Buffer/Transfer page without saving changes.

Setting	Description
Lens Position When Triggered	<ul style="list-style-type: none"> <li>• Set [Move to alarm position] to move the lens to the alarm position (see page 28) when the alarm signal is detected.</li> </ul>

6. Set the image settings, and click [Next>].

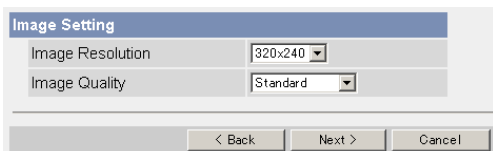

- Clicking [<Back] takes you back to the previous page.
- Clicking [Cancel] takes you back to the Image Buffer/Transfer page without saving changes.

Setting	Description
Image Resolution	<ul style="list-style-type: none"> <li>• Select image resolution (640 x 480, 320 x 240 (default) or 160 x 120 pixels) to buffer or transfer.</li> </ul>
Image Quality	<ul style="list-style-type: none"> <li>• Select the image quality.                      [Favor Clarity] optimizes for good quality.                      [Standard] offers standard quality.                      [Favor Motion] optimizes for enhanced motion.                      [Mobile Phone] is for a transfer to a cell phone.</li> </ul> <p><b>Note</b> 640 x 480 pixels cannot be set for a transfer to a cell phone.</p>

## 7. Set the image buffer frequencies, and click [Next>].

### Note

Due to the network environment, object, number of accesses, enabling IPsec, SD memory recording, the camera may not record the numbers of images as you set. In this case, set the image buffer frequencies longer. For the SD memory recording, 1 image per second setting is recommended.

- Clicking [<Back] takes you back to the previous page.
- Clicking [Cancel] takes you back to the Image Buffer/Transfer page without saving changes.

Setting	Description
Enable Pre-trigger Image Buffer	<ul style="list-style-type: none"> <li>• Check the box to enable the setting. The camera buffers or transfers the image right before the alarm signal is detected.</li> <li>• Set an interval, number of images to buffer and total number. The buffered images may not match the total number due to memory capacity, image resolution, image quality or what object you view.</li> </ul>
Enable Post-trigger Image Buffer	<ul style="list-style-type: none"> <li>• Check the box to enable the setting. The camera buffers or transfers the image right after the alarm signal is detected.</li> <li>• Set an interval, number of images to buffer and total number. The buffered images may not match the total number due to memory capacity, image resolution, image quality or what object you view.</li> </ul>

**8.** Select the transfer method, and click [Next>].

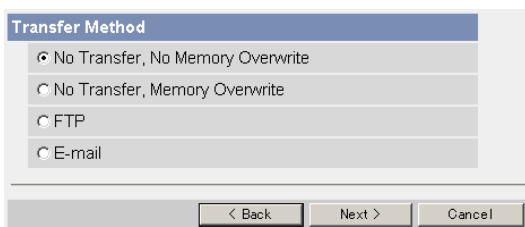

- Clicking [<Back] takes you back to the previous page.
- Clicking [Cancel] takes you back to the Image Buffer/Transfer page without saving changes.

**Note**

If you transfer image by E-mail or FTP, confirm that the default gateway and DNS server addresses are assigned correctly (see page 44 and page 49).

Setting	Description
No Transfer, No Memory Overwrite	• If the internal memory or the SD memory card is full, the camera stops the buffer.
No Transfer, Memory Overwrite	• If the internal memory or the SD memory card is full, the camera deletes the old images, and continues to buffer the image.
FTP	• The camera transfers the image to an FTP server (see page 105).
E-mail	• The camera transfers the image by E-mail (see page 107).



### When you set [FTP] for Transfer Method

Select [FTP], and click [Next>]. The following page is displayed.

FTP	
Server IP Address or Host Name	<input type="text"/>
Port No. (Usually Use 21)	<input type="text" value="21"/>
Login ID (0 to 63 Characters)	<input type="text"/>
Password (0 to 63 Characters)	<input type="password"/>
Login Timing	<input type="text" value="Every Time"/> ▾
Upload File Name (1 to 234 Characters)	<input type="text"/>
Overwrite setting	<input type="text" value="Overwrite File"/> ▾
Data Transfer Method	<input type="text" value="Passive Mode"/> ▾

- Clicking [**<Back**] takes you back to the previous page.
- Clicking [**Cancel**] takes you back to the Image Buffer/Transfer page without saving changes.

Setting	Description
Server IP Address or Host Name <sup>1</sup>	<ul style="list-style-type: none"> <li>If you set the server IP address, set 4 digits (0—255) and 3 periods such as "192.168.0.253". But "0.0.0.0" and "255.255.255.255" are not available. Or set a host name (1—255 characters).</li> <li>You can set IPv6 address.</li> </ul>
Port No.	<ul style="list-style-type: none"> <li>Enter the number (1—65535). Usually set to 21.</li> </ul>
Login ID <sup>2</sup>	<ul style="list-style-type: none"> <li>If your ISP requires a login ID, set it (0—63 characters).</li> </ul>
Password <sup>2</sup>	<ul style="list-style-type: none"> <li>If your ISP requires a password, set it (0—63 characters).</li> </ul>
Login Timing	<ul style="list-style-type: none"> <li>Select the login timing to an FTP server. If you set [One Time] during 1-minute transfer, the camera logs in to the server only once, and can reduce the time to log in or log out.</li> </ul>
Upload File Name <sup>1</sup>	<ul style="list-style-type: none"> <li>Set the file name to save on an FTP server. Enter 1—234 characters. Entering "\" creates directories for a file. (E.g. NetworkCamera\image.jpg)</li> </ul>
Overwrite Setting	<ul style="list-style-type: none"> <li>Selecting [Overwrite File] saves and overwrites the image on the server. Selecting [Save as New File with Time Stamp] saves the image attaching time stamps on the file name, and the images are not overwritten.</li> </ul>
Data Transfer Method	<ul style="list-style-type: none"> <li>Select [Passive Mode] normally. If FTP does not work, select [Active Mode] and check the operation.</li> </ul>

<sup>1</sup> But [Space], ["], ['], [&], [<] and [>] are not available.

<sup>2</sup> But ["] is not available.

## When you set [E-mail] for Transfer Method

Select [E-mail], and click [Next>]. The following page is displayed.

E-mail Transfer	
SMTP Server IP Address or Host Name	<input type="text"/>
Port No. (Usually Use 25)	<input type="text" value="25"/>
POP3 Server IP Address or Host Name	<input type="text"/>
Port No. (Usually Use 110)	<input type="text" value="110"/>
Login ID (0 to 63 Characters)	<input type="text"/>
Password (0 to 63 Characters)	<input type="text"/>
Reply E-mail Address	<input type="text"/>
Destination E-mail Address 1	<input type="text"/>
Destination E-mail Address 2	<input type="text"/>
Destination E-mail Address 3	<input type="text"/>
Subject (Up to 44 Characters)	<input type="text"/>
Text (Up to 63 Characters)	<input type="text"/>
<input type="button" value=" &lt; Back"/> <input type="button" value=" Next &gt; "/> <input type="button" value=" Cancel "/>	

- Clicking [<Back] takes you back to the previous page.
- Clicking [Cancel] takes you back to the Image Buffer/Transfer page without saving changes.

### Note

The camera works only with an SMTP (Simple Mail Transfer Protocol) server. It does not work with mail servers like "Hotmail" using a web browser.

Setting	Description
SMTP Server IP Address or Host Name <sup>1</sup>	<ul style="list-style-type: none"> <li>If you set the server IP address, set 4 digits (0—255) and 3 periods such as "192.168.0.253". But "0.0.0.0" and "255.255.255.255" are not available. Or set a host name (1—255 characters).</li> <li>You can set IPv6 address.</li> </ul>
Port No.	<ul style="list-style-type: none"> <li>Enter the number (1—65535). Usually set to 25.</li> </ul>
POP3 Server IP Address or Host Name <sup>1</sup>	<ul style="list-style-type: none"> <li>If you set the server IP address, set 4 digits (0—255) and 3 periods such as "192.168.0.253". But "0.0.0.0" and "255.255.255.255" are not available. Or set a host name (1—255 characters).</li> <li>You can set IPv6 address.</li> </ul>
Port No.	<ul style="list-style-type: none"> <li>Enter the number (1—65535). Usually set to 110.</li> </ul>
Login ID <sup>2</sup>	<ul style="list-style-type: none"> <li>If your ISP requires a login ID to log in to a POP3 server, set it (0—63 characters).</li> </ul>
Password <sup>2</sup>	<ul style="list-style-type: none"> <li>If your ISP requires a password to log in to a POP3 server, set it (0—63 characters).</li> </ul>
Reply E-mail Address <sup>2</sup>	<ul style="list-style-type: none"> <li>Set the sender's E-mail address. We recommend you to set the administrator's E-mail address.</li> </ul>
Destination E-mail Address <sup>2</sup> 1—3	<ul style="list-style-type: none"> <li>Set the destination E-mail address (up to 3).</li> </ul>
Subject <sup>2</sup>	<ul style="list-style-type: none"> <li>Enter a subject with ASCII characters (see page 150) or characters in each language (0—44 characters for a 1-byte character and 0—22 characters for a 2-byte character).</li> </ul>
Text	<ul style="list-style-type: none"> <li>Enter text with ASCII characters (see page 150) or characters in each language (0—63 characters for a 1-byte character and 0—31 characters for a 2-byte character). But ["] and [end-of-line] key are not available.</li> </ul>

<sup>1</sup> But [Space], ["], ['], [&], [<] and [>] are not available.

<sup>2</sup> But ["] is not available.

9. After you confirm the settings and click [Next>], set E-mail notification and click [Next>].

The screenshot shows a settings menu titled "E-mail notification when triggered". The "Disable" option is selected with a radio button. Below the options are three navigation buttons: "< Back", "Next >", and "Cancel".

- If you select [Enable], the E-mail Notification When Triggered page is displayed. Enter the settings seeing page 107 and page 108. When finished, click [Next>] and go to step 10.

Setting	Description
Disable	<ul style="list-style-type: none"> <li>• The camera does not send an E-mail notification when buffering or transferring image.</li> </ul>
Enable	<ul style="list-style-type: none"> <li>• The camera sends an E-mail notification (up to 3 destinations) when buffering or transferring image.</li> </ul>

10. Click [Save] after confirming the settings.

- New settings are saved.
- When finished, "Success!" is displayed.

### **Note**

If you click [Save], all buffered images on the SD memory card are deleted.

**11.** Click [Go to Image Buffer/Transfer page].

- The Image Buffer/Transfer page is displayed.

**Note**

- If you set a short interval to transfer image to a cell phone, many E-mails may be sent to it leading to a large phone bill. Therefore, we recommend you to set a long interval. 1 image per second frequency is recommended.
- Alarm transfer stops its operations until the camera finishes all transfers. For example, if the camera transfers 3 images per minute and 6 images in total, the alarm detection will be in the following operation.

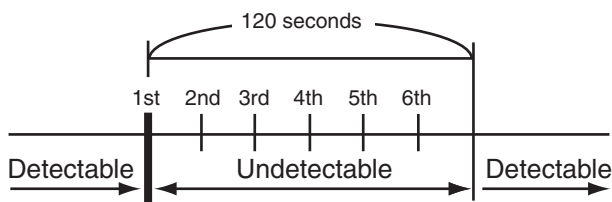

An alarm signal is detected.

- If you are buffering images on the internal memory, the following operations also delete all buffered images.
  - Turning off the camera.
  - Saving the Date and Time page.
  - Restarting, updating firmware or resetting the camera to factory default.

## 2.21 Transfer the Camera Image in Transport Mode

The camera can transfer the image in transport mode by E-mail or FTP.

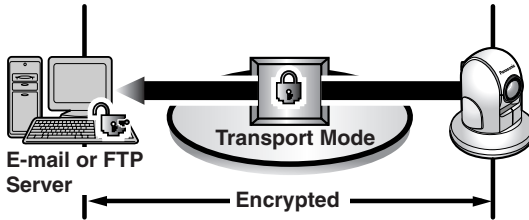

Prepare the following requirements.

Item	Supported Feature	
E-mail or FTP Server	Operating System ISP Service	: IPsec supported : Services for multiple static global addresses (A global address must be set up to the server.)
Camera	ISP Service	: Services for multiple static global addresses (A global address must be set up to the camera.)

See page 56 and set up the E-mail or FTP server.

## 2.22 Transfer the Camera Image in Tunnel Mode

The camera can transfer the image in tunnel mode by E-mail or FTP.

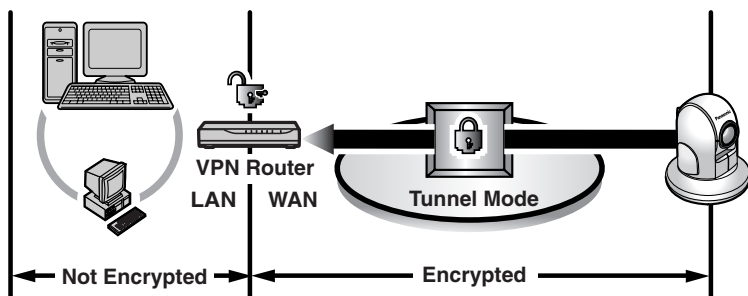

Prepare the following requirements.

Item	Supported Feature
VPN Router	ISP Service (in IPv4) : Services for static global addresses (A global address must be set up to the WAN side.) ISP Service (in IPv6) : "IPv4/IPv6 Dual-Stack" or "IPv6 over IPv4 Tunneling" service
Camera	ISP Service (in IPv4) : Services for multiple static global addresses (A global address must be set up to the camera.) ISP Service (in IPv6) : "IPv4/IPv6 Dual-Stack" or "IPv6 over IPv4 Tunneling" service

See page 59 and set up the E-mail or FTP server.



## 2.23 Specifying Operation Time

The Operation Time page allows you to limit the operation time. The camera image turns to a gray screen outside the operation time.

### Note

- If you wrongly set the time period, your privacy may be seen. Confirm the time period after the setup.
- If you access the camera as an administrator, you can view the image outside the time period.

1. Click [Operation Time] on the Setup page.
2. Click [No.] to set the operation time.

Operation Time										
No.	Status	Sun	Mon	Tue	Wed	Thu	Fri	Sat	Operation Time	
1	Disable	X	X	X	X	X	X	X	Always	
2	Disable	X	X	X	X	X	X	X	Always	
3	Disable	X	X	X	X	X	X	X	Always	
4	Disable	X	X	X	X	X	X	X	Always	
5	Disable	X	X	X	X	X	X	X	Always	
6	Disable	X	X	X	X	X	X	X	Always	
7	Disable	X	X	X	X	X	X	X	Always	

### Note

If No. 1—7 are disabled, the camera can always be operated.

3. Check [Enable], set the time, and click [Save]

Operation Time											
Enable	Sun	Mon	Tue	Wed	Thu	Fri	Sat	Operation Time			
<input type="checkbox"/>	<input checked="" type="checkbox"/>	<input checked="" type="checkbox"/>	<input checked="" type="checkbox"/>	<input checked="" type="checkbox"/>	<input checked="" type="checkbox"/>	<input checked="" type="checkbox"/>	<input checked="" type="checkbox"/>	<input checked="" type="checkbox"/>	<input checked="" type="radio"/> Always	to <input type="text" value="AM"/> <input type="text" value="12"/> <input type="text" value="0"/> min to <input type="text" value="AM"/> <input type="text" value="12"/> <input type="text" value="0"/> min	
<input type="button" value="Save"/> <input type="button" value="Cancel"/>											

- Clicking [Cancel] takes you back to the previous page.

Setting	Description
Enable	<ul style="list-style-type: none"> <li>Check the box to enable the setting. Clear the box to disable it.</li> </ul>
A day of the week	<ul style="list-style-type: none"> <li>Check the box to enable the day. Clear the box to disable it.</li> </ul>
Operation Time	<ul style="list-style-type: none"> <li>Select the [Always] option when you do not specify the time period. If you specify the time period, select the time period option and set the time period.</li> </ul>

**4.** Click [Save] when finished.

- New settings are saved.
- The Operation Time page is displayed.

## About Operation Time

In the operation time settings, the enabled settings take priority over the disabled settings. Therefore, if Monday or Tuesday is disabled in a setting but enabled in other settings, the camera can be operated on both Monday and Tuesday.

No.	Status	Sun	Mon	Tue	Wed	Thu	Fri	Sat	Operation Time
1	Enable	X	X		X	X	X	X	Always
2	Enable	X		X	X	X	X	X	Always

### Note

An administrator can view images anytime regardless of the setting for the operation time.

## 2.24 Controlling External Output Terminal

The digital output terminal allows you to control the external devices. You can change the initial status of the output signal.

1. Click [External Output] on the Setup page.
2. Click [Save] when finished.

- Clicking [Cancel] cancels your settings without saving changes.
- New settings are saved.
- When finished, "Success!" is displayed.

Setting	Description
External Device Control Output	<ul style="list-style-type: none"> <li>• If you check [Open], the internal transistor turns off and the external output terminal gets high impedance (open collector) when the camera powers up. If you check [Short to GND], the internal transistor turns on and is electrically short-circuited to GND pin when the camera powers up. The external output terminal gets low impedance (0 V).</li> </ul>
Button name modification	<ul style="list-style-type: none"> <li>• You can change the output control button names on the operation bar. You can name the button depending on your external devices.</li> </ul>

3. Click [Go to External Output Control page].
  - The External Output Control page is displayed.

## 2.25 Changing Indicator Display

The Indicator Control page allows you to select Indicator operation. Indicator has three options.

- Always on
  - Turn the indicator on when the camera is accessed.
  - Always off
1. Click [Indicator Control] on the Setup page.
  2. Select indicator option.

The screenshot shows a dialog box titled "Indicator Control". It contains three radio button options for selecting indicator operation. The first option, "Turn indicator on when camera is on.", is selected. The second option is "Turn indicator on during camera access.", and the third is "Never turn indicator on.". At the bottom right of the dialog, there are two buttons: "Save" and "Cancel".

- Clicking [Cancel] cancels your settings without saving changes.

### **Note**

- See page 11 in the Installation/Troubleshooting for indicator display.
  - Selecting [Never turn indicator on] keeps indicator always off.
3. Click [Save] when finished.
    - New settings are saved.
    - When finished, "Success!" is displayed.
  4. Click [Go to Indicator Control page].
    - The Indicator Control page is displayed.

## 3 Camera Maintenance

### 3.1 Maintenance page

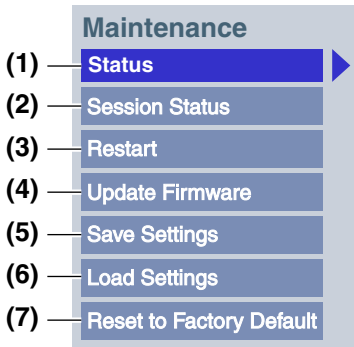

---

#### Maintenance

- |                                     |  |
|-------------------------------------|--|
| (1) <b>Status</b>                   | Displays the camera settings and status (see page 118).      |
| (2) <b>Session Status</b>           | Displays information on access to the camera (see page 118). |
| (3) <b>Restart</b>                  | Restarts the camera (see page 119).                          |
| (4) <b>Update Firmware</b>          | Updates the camera firmware (see page 120).                  |
| (5) <b>Save Settings</b>            | Creates a configuration file (see page 123).                 |
| (6) <b>Load Settings</b>            | Loads settings from a configuration file (see page 124).     |
| (7) <b>Reset to Factory Default</b> | Resets the camera to its default settings (see page 125).    |
-

### 3.1.1 Confirming the Status

The Status page allows you to check the status of the camera. The status information provides support for troubleshooting.

Clicking [Status] displays the following page.

Version	
Displays Hardware/Firmware Version.	
Model	*****
Firmware(Boot)	* **
Firmware(Application)	* **

#### Note

See Panasonic Network Camera support website at <http://panasonic.co.jp/pcc/products/en/netwkcaml/> for details about status information.

### 3.1.2 Confirming Session Status

Displays client information connecting to camera.

Clicking [Session Status] displays the following page.

Number of sessions		
Show number of motion and audio sessions.		
div	max sessions	now sessions
motion	30	4
audio	10	1
List of sessions		
Display max 40 tables connecting now.		
	Addr-Port	User

### 3.1.3 Restarting the Camera

The Restart page can restart the camera. The camera can also be restarted by pressing the RESTART button or by disconnecting the power cord from the outlet and reconnecting it again.

#### **Note**

When the camera restarts, the buffered images will be deleted. The buffered images on the SD memory card are not deleted.

1. Click [Restart] on the Maintenance page.
2. Click [Restart].

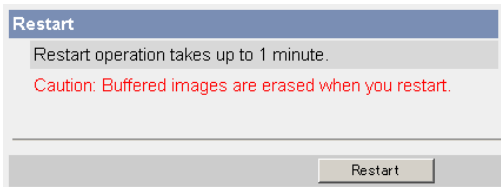

- Restarting takes about 1 minute. The Top page is displayed when finished.

### 3.1.4 Updating the Camera Firmware

The Update Firmware page allows you to update the camera firmware. If the new firmware is available, install it into the camera.

#### Note

- Do not turn off the power during firmware update.
  - All buffered images on the internal memory will be deleted after the firmware update. The buffered images on the SD memory card are not deleted.
  - The firmware version is displayed on the Top page and the Status page.
1. Download the new firmware on the Panasonic Network Camera support website at <http://panasonic.co.jp/pcc/products/en/netwcam/>, and save it on your PC.
  2. Click [Update Firmware] on the Maintenance page.
  3. Click [Update Firmware].

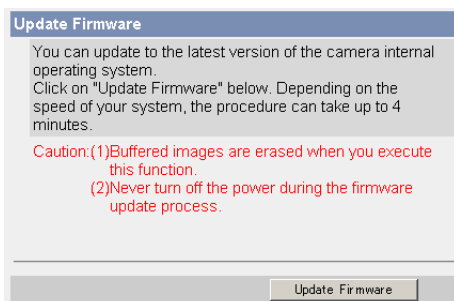

- The camera restarts.

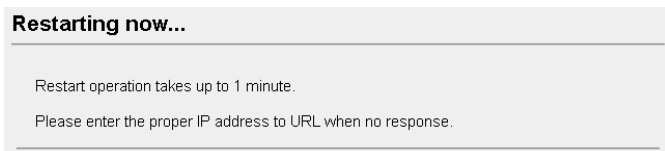



- The Update page is displayed in about 1 minute.

Please enter or browse the firmware file name for update.

File Name

The firmware update process takes about 180 seconds via "File Upload", "Flash-ROM Writing", and "Restart", automatically.

**Caution:** Never turn off the power, during the firmware update process.

4. Click [Browse...].
  - A dialog box is displayed to select the firmware.
5. Select the firmware (including directory information) and click [Open].
  - The firmware file name is displayed.
6. Confirm the firmware file name, and click [Update Firmware].
  - Clicking [Cancel] takes you back to the Top page without firmware update.
  - The next message is displayed during update.

#### Updating firmware.

Please wait about 180 seconds.

**Caution:** Never turn off the power, during the firmware update process.

- The camera restarts automatically after update.

#### Restarting now...

Restart operation takes up to 1 minute.

Please enter the proper IP address to URL when no response.

- The Top page is displayed in about 1 minute.

7. Confirm that the version number on the Top page is updated.



- If the version number is updated, the firmware update is complete.

### 3.1.5 Creating Configuration File

A configuration file can be saved on your PC. You can load the camera settings from the configuration file on the Load Settings page (see page 124).

#### Note

The saved image has privacy information. Prevent private information leaks.

1. Click [Save Settings] on the Maintenance page.
2. Click [Save].



3. Click [Save] on the File Download dialog box.
4. Specify the location, and click [Save] on the Save As dialog box.

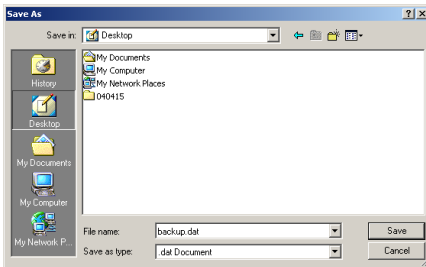

- The configuration file is saved in the location.

#### Note

- The file extension (.dat) cannot be changed. If you change it, the settings cannot be loaded.
- If you try to updating the camera, create a configuration file after updating the firmware. If there is a firmware version difference between the camera that you create a configuration file from and the camera that you try to load settings to, the settings may not be loaded to the camera.

### 3.1.6 Loading Settings from a Configuration File

The settings can be loaded from a configuration file. If you reset the camera to factory default, the camera can load its settings from the configuration file.

**Note**

- The configuration file has network settings. When the settings are loaded, the network settings are also loaded as they were saved.
  - If you try to update the camera, create a configuration file after updating the firmware. If there is a firmware version difference between the camera that you create a configuration file from and the camera that you try to load settings to, the settings may not be loaded to the camera. Save settings after updating the firmware.
1. Click [Load Settings] on the Maintenance page.
  2. Click [Browse...].

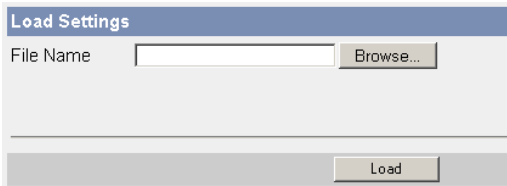

3. Select the configuration file on the Choose file dialog box, and click [Open].

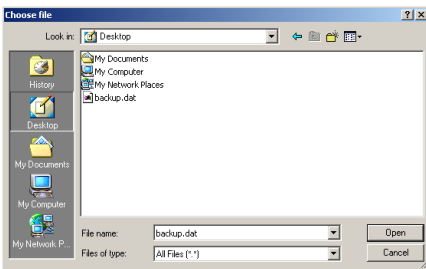

- The file name is displayed in the data field.
4. Confirm the file name, and click [Load].
  5. Click [Restart].
    - The camera restarts, and the Top page is displayed.

### 3.1.7 Resetting the Camera to Factory Default

All camera settings are reset to factory default directly after the Execute button is clicked.

1. Click [Reset to Factory Default] on the Maintenance page.
2. Click [Execute].

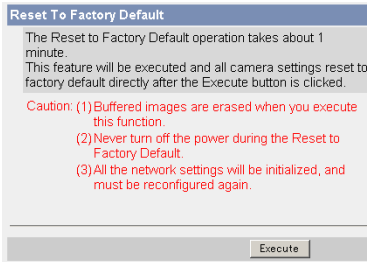

- The indicator blinks orange, and then turns off for 10 seconds.
- All camera settings (user name, password, IP address, subnet mask etc.) are reset to factory default.
- If the camera is reset to factory default, the network connection mode changes to [Automatic Setup]. Reconfigure the camera refer to the Installation/Troubleshooting if necessary.

#### **Note**

- The internal clock will not be reset, but the time format will return to AM/PM mode (see page 67). Set it again.
- See page 131—page 139 for default settings.
- Pressing the FACTORY DEFAULT RESET button resets the camera to the factory default (see page 130).
- All buffered images on the internal memory are deleted when resetting the camera to factory default. The buffered images on the SD memory card are not deleted.
- The reset operation takes about 1 minute.
- Do not turn off the camera during the reset operation.

## 3.2 Support page



---

### Support

- |                                |  |
|--------------------------------|--|
| (1) <b>Help</b>                | Displays the Help page (see page 126).               |
| (2) <b>Product Information</b> | Displays product information website (see page 126). |
| (3) <b>Support Information</b> | Displays support information website (see page 127). |
- 

### 3.2.1 Seeing Help page

The Help page displays explanations for each feature about the following 1. to 6. items.

Clicking [Help] on the Support page displays the next page.

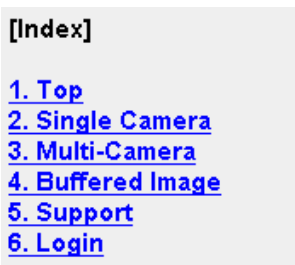

### 3.2.2 Seeing Product Information

You can see product information on the Panasonic Network Camera support website.

Clicking [Product Information] on the Support page displays the URL, click it.

#### **Note**

If the camera is not connected to the Internet, the website cannot be displayed.

### 3.2.3 Seeing Support Information

You can see support information on the Panasonic Network Camera support website.

Clicking [Support Information] on the Support page displays the URL, click it.

#### **Note**

If the camera is not connected to the Internet, the website cannot be displayed.

### 3.3 External I/O

If you connect the external devices such as sensors to the External I/O and image buffer/transfer by alarm signal is set, the camera image is transferred by the alarm detection.

#### Explanation of the External I/O

Pin	Features
G	GND pin
1	External Sensor Input 1 <ul style="list-style-type: none"> <li>Use it by opening or GND short-circuit.</li> </ul>
G	GND pin
2	External Sensor Input 2 <ul style="list-style-type: none"> <li>Use it by opening or GND short-circuit.</li> </ul>
3	External Device Control Output <ul style="list-style-type: none"> <li>You can control it on the External Output page (see page 115).</li> <li>It is an open collector circuit, and the maximum drawing-in current is the same as pin 4. Do not exceed the voltage of DC power output terminal (pin 4).</li> </ul>
4	DC Power Output Terminal <ul style="list-style-type: none"> <li>10.5—13.5 V DC</li> <li>Maximum of 100 mA load drive is possible.</li> </ul>

#### **Note**

The External I/O (Input/Output) are independent. Output terminal is controlled only by External Output Control page on page 115.



### Circuit Diagram Example

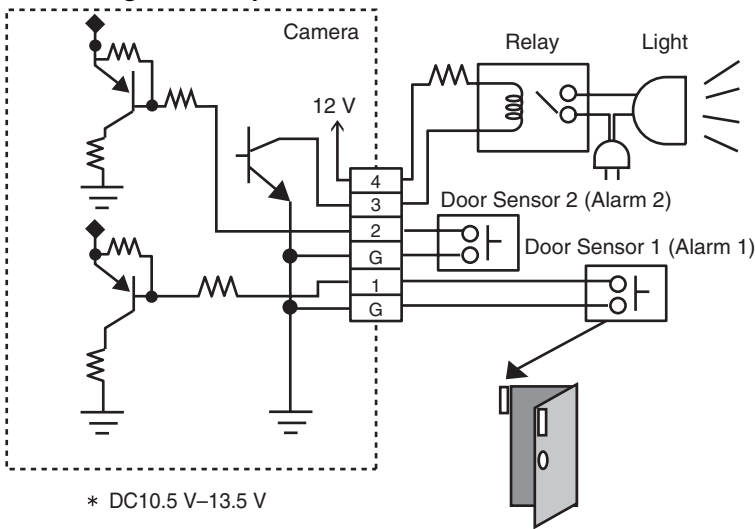

### CAUTION

- The external I/O is not capable of connecting directly to devices that require large amounts of current. In some case, a custom interface circuit (customer-provided) may have to be used. Serious damage to the camera may result if a device is connected to the external I/O that exceeds its electrical capability (see page 128).
- The low voltage/current circuits and high voltage/current circuits are in the camera circuit. The qualified electrician should do the wiring not by yourself. Incorrect wiring could damage the camera. You could receive the fatal electric shock.

## 3.4 FACTORY DEFAULT RESET Button

The camera has a FACTORY DEFAULT RESET button.

FACTORY DEFAULT RESET button  
(Press the button with a pointed object)

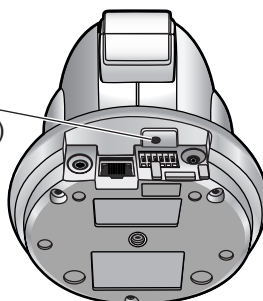

Pressing the FACTORY DEFAULT RESET button resets the camera to factory default. If you lose your user name and password, use this button to reset the camera.

- Press the FACTORY DEFAULT RESET button for 1 second when the camera is on.
- The indicator blinks orange, and then turns off for 5 seconds.
- Do not turn off the camera until the indicator lights green.

### **Note**

- The internal clock will not be reset, but the time format will return to AM/PM mode (see page 67). Set it again.
- See page 131—page 139 for default settings.
- All buffered images on the internal memory are deleted when resetting the camera to factory default. The buffered images on the SD memory card are not deleted.
- The reset operation takes about 1 minute.

## 3.5 Default Setting List

### Basic

	Items	Default	Required	Note
Network (IPv4)	Connection Mode	Automatic Setup	-	Automatic Setup/Static/DHCP
	Allow Access from the Internet (Automatic Setup only)	No	-	-
	Network Configuration from Setup Program (Static/DHCP only)	Enable	-	-
	Port No. (Static/DHCP only)	80	-	20, 21, 25 and 110 is not available*2.
	IP address (Static only)	192.168.0.253	When setting Static	*1
	Subnet Mask (Static only)	255.255.255.0	When setting Static	*1
	Host Name (DHCP only)	[Blank]	When setting DHCP (Not always required)	0—63 characters *4
	Default Gateway (Static/DHCP only)	[Blank]	When using Gateway	*1
	DNS Server 1 DNS Server 2 (Static/DHCP only)	[Blank]	When using DNS	*1
	Max. Bandwidth Usage (Mbps)	Unlimited	-	0.1, 0.2, 0.3, 0.5, 1 or Unlimited
Connection Type	Auto Negotiation	-	-	

Items		Default	Required	Note
Network (IPv6)	Connection Mode	Automatic Setup	-	Automatic Setup/Static
	Allow Access from the Internet (Automatic Setup only)	No	-	-
	Port No. (Static only)	80	-	20, 21, 25 and 110 is not available.
	IP address (Static only)	[Blank]	When setting Static	*1
	Default Gateway (Static only)	[Blank]	When using Gateway	*1
	DNS Server 1 DNS Server 2	[Blank]	When using DNS	*1
	Max. Bandwidth Usage (Mbps)	Unlimited	-	0.1, 0.2, 0.3, 0.5, 1 or Unlimited
	Connection Type	Auto Negotiation	-	-
IPsec	Use	No check	-	-
	Encoding strength	Standard (AES, 3DES, DES, NULL)	-	Standard/High
	Transport	[Blank]	-	-
	Tunnel	[Blank]	-	-
UPnP	Auto Port Forwarding	Disable	-	-
	Display Shortcut Icon in My Network Places	Enable	-	-
Viewnet cam.com	Enable	No check	-	-

	<b>Items</b>	<b>Default</b>	<b>Required</b>	<b>Note</b>
Date and Time	Time Setting	AM/PM	-	-
	Automatic Time Adjustment	No check	When using NTP	-
	Time Zone	GMT -05:00	-	-
	Adjust Clock for Daylight Saving Time	No check	-	-
	Start Day	Apr, First Sunday, 2 AM	-	-
	End Day	Oct, Last Sunday, 2 AM	-	-
Camera	Camera Name	Network Camera	Required	1—15 characters *6
	White Balance	Auto	-	Auto/Fixed Indoor/Fixed Fluorescent (White)/Fixed Fluorescent (Daylight)/Fixed Outdoor/Hold
	AC Power Source Frequency	60 Hz	-	60 Hz, 50 Hz
	Automatic Focus Range	Macro	-	Macro, Normal
	Mounting Type	On the table	-	On the table, On the ceiling
	Pan Range (Minimum)	-175 degrees	-	-175 — +175 degrees, current
	(Home Position)	0 degrees	-	-175 — +175 degrees, current
(Maximum)	+175 degrees	-	-175 — +175 degrees, current	

Items		Default	Required	Note
	Tilt Range (On the table)	Selected	-	-
	(Minimum)	-120 degrees	-	-120 — 0 degrees, current
	(Home Position)	-90 degrees	-	-120 — 0 degrees, current
	(Maximum)	0 degrees	-	-120 — 0 degrees, current
	Tilt Range (On the ceiling)	Not-selected	-	-
	(Minimum)	0 degrees	-	0 — +90 degrees, current
	(Home Position)	+90 degrees	-	0 — +90 degrees, current
	(Maximum)	+90 degrees	-	0 — +90 degrees, current
	Return to Specified Position (Time)	Do not move	-	Do not move, 10, 30 (min), 1 h
	(Specified Position)	Home Position	-	Home Position/ Preset No. 1—8/ Alarm No. 1, 2
	Color Night View	Disable	-	-
	Vertical Resolution (for 640 x 480 mode)	480	-	480, 240

Items		Default	Required	Note
Audio	Output	Enabled	-	-
	Volume	Standard	-	Minimum/ Standard/ Maximum
	PC Audio Input Timeout	1 min	-	1, 2, 3, 5, 10, 20, 30, 60 (min)
	Input	Enable	-	-
	Camera Microphone Sensitivity	Standard	-	Minimum/ Standard/ Maximum
	Mute during Pan/Tilt	Enable	-	-

## Account

Items		Default	Required	Note
Security: Administrator	General Authentication	Do not permit access from guest users	-	-
	User Name	[Blank]	When setting administrator	6—15 characters *3
	Password	[Blank]	When setting administrator	6—15 characters *3
	Retype Password	[Blank]	When setting administrator	6—15 characters *3

Items		Default	Required	Note
General User	User ID List	[Blank]	-	-
	User Name	[Blank]	When setting general user	6—15 characters *3
	Password	[Blank]	When setting general user	6—15 characters *3
	Retype Password	[Blank]	When setting general user	6—15 characters *3
	Limit time of Continuous Motion JPEG	Not permitted	-	Not permitted, Unlimited, 10, 30 (s), 1, 5, 10, 30, 60 (min)
	Refresh Interval	3 s	-	3, 5, 10, 30, 60 (s)
	Access Level	No checks	-	-



## Advanced

Items		Default	Required	Note
Image Display	Single Camera Image Resolution	320 x 240	-	320 x 240 or 640 x 480
	Single Camera Image Quality	Standard	-	Favor Clarity, Standard or Favor Motion
	Single Camera Refresh Interval	Motion	-	3, 5, 10, 30, 60 (s) or Motion
	Multi-Camera Image Resolution	320 x 240	-	160 x 120 or 320 x 240
	Multi-Camera Image Quality	Standard	-	Favor Clarity, Standard or Favor Motion
	Multi-Camera Refresh Interval	Motion	When reducing traffic	3, 5, 10, 30, 60 (s) or Motion
	Time stamp setting	Not used	-	Not used/AM/PM format/24H format
	Language	English	-	English/ Japanese/ French/German/ Italian/Spanish/ Simplified Chinese/Russian
	Banner Display (Administrator)	Checked	-	-
(General User)	Checked	-	-	

	Items	Default	Required	Note
Multi-Camera	Multi-Camera	[Blank]	-	-
	Display	Checked	When setting Multi-Camera	-
	IP Address or Host Name	[Blank]	When setting Multi-Camera	IP address*1 Host name*5 is 1—255 characters.
	Port No.	[Blank]	When setting Multi-Camera	20, 21, 25 and 110 are not available*2.
	Camera Name	[Blank]	When setting Multi-Camera	1—15 characters*7
Buffer/Transfer	Status	Off	-	-
	Trigger	Timer	-	-
	Active Time of Trigger	Always	-	-
	Image Setting (Image Resolution)	320 x 240	-	160 x 120, 320 x 240, 640 x 480
	(Image Quality)	Standard	-	Favor Clarity, Standard, Favor Motion, Mobile Phone
	Image Buffer Frequency	Every 1 s, buffer 1 image.	-	1 image per hour—30 images per second
	Transfer Method	No Transfer, No Memory Overwrite	-	-
	Notify	-	-	-
Operation Time	Operation Time	Always	-	-
External Output	External Device Control Output	Open	-	Open/Short to GND
	Button name modification	Open/Short	-	-

Items		Default	Required	Note
Indicator Control	Indicator Control	Turn indicator on when camera is on	-	-

\*1 In IPv4, set 4 digits (0—255) and 3 periods such as "192.168.0.253". But "0.0.0.0" and "255.255.255.255" are not available.

In IPv6, set 8 hexadecimal digits divided with ":". Consecutive 0s can be abbreviated as "::".

\*2 Set the number of 1—65535.

\*3 Enter ASCII characters (see page 150). But [Space], ["], ['], [&], [<], [>] and [:] are not available.

\*4 Enter ASCII characters for the host name (see page 150). But [Space], ["], ['], [&], [<], and [>] are not available.

\*5 Enter ASCII characters for the host name (see page 150). But [Space], ["], ['], [#], [&], [%], [=], [+], [?], [<], and [>] are not available.

\*6 Enter ASCII characters (see page 150) or characters in each language (1—15 characters for a 1-byte character and 1—7 characters for a 2-byte character). But [Space], ["], ['], [&], [<], and [>] are not available.

\*7 Enter ASCII characters (see page 150) or characters in each language (1—15 characters for a 1-byte character and 1—7 characters for a 2-byte character). But [Space], ["], ['], [#], [&], [%], [=], [+], [?], [<], and [>] are not available.

## 3.6 Cleaning

After the camera is turned off by disconnecting the AC plug, clean the camera.

### 3.6.1 Cleaning the Main Unit

If the lens has the sand or the dust, image quality may decrease. After taking away the sand or the dust on it, wipe it with lens cleaning paper.

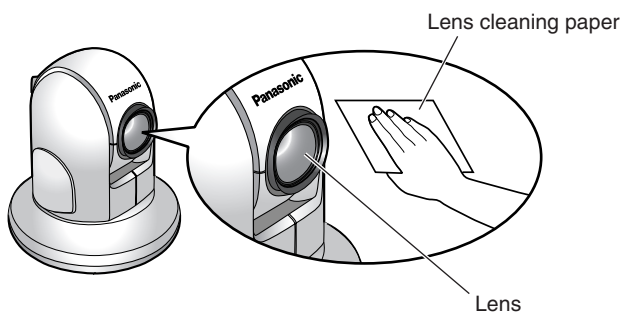

#### **Note**

- Do not use alcohol, polishing powder, cleanser, benzine, thinner, wax, petroleum products or hot water to wipe the camera. Also avoid glass cleaner, pesticide or hair spray. They may cause change in the shape or color.
- Do not directly touch the lens. Your fingerprints can cause the image to be out of focus.

## 3.7 Setting an IP Address on Your PC

Your PC's IP address can be assigned by the following procedures.

1. Display the TCP/IP Properties window.
  - The steps are different depending on your OS. The steps are shown below.

OS	Steps
Windows XP	[Start] (→[Settings])→[Control Panel]→[Network and Internet Connections]→[Network Connections]→[Local Area Connection] in use→[Properties]→Select Internet Protocol [TCP/IP]→[Properties]→[Use the following IP address]
Windows 2000	[Start]→[Settings]→[Control Panel]→[Network and Dial-up Connections]→[Local Area Connection] in use→[Properties]→Select Internet Protocol [TCP/IP]→[Properties]→[Use the following IP address]
Windows Me, Windows 98SE	[Start]→[Settings]→[Control Panel]→[Network]→Select [TCP/IP] with adaptor in use→[Properties]→[IP Address]→[Specify an IP address]

- When using Windows XP and Windows 2000, log in as an administrator to access the TCP/IP Properties window.
2. Enter IP address and subnet mask.
  3. Click [OK].
    - In Windows Me or Windows 98SE, the PC needs to be restarted to enable the settings.

### Local IP Address

Local IP address is the network ID that is not used on the Internet. They are classified into Class A, Class B and Class C, as shown below. Set the IP address in the range of the number specified in the class corresponding to your local network scale.

Class	Subnet Mask	Local IP Address		
Class A	255. 0. 0. 0	10. 0. 0. 1	—	10. 255. 255. 254
Class B	255. 255. 0. 0	172. 16. 0. 1	—	172. 31. 255. 254
Class C	255. 255. 255. 0	192. 168. 0. 1	—	192. 168. 0. 254

### 3.8 Using Setup Program

The Setup Program can be used for the following purposes.

- Finding the IP address and port number of the camera connected to your network.
- Setting up the camera automatically.
- Setting up the camera manually to a Static or a DHCP setting.
- Disabling IPsec.
- Displaying the Setup page.

#### Finding the camera

1. Insert the Setup CD-ROM into the CD-ROM drive of your PC.
  - If the Panasonic Network Camera Setup window does not appear, click "setup.exe" on the Setup CD-ROM.
2. Click [Camera Setup].

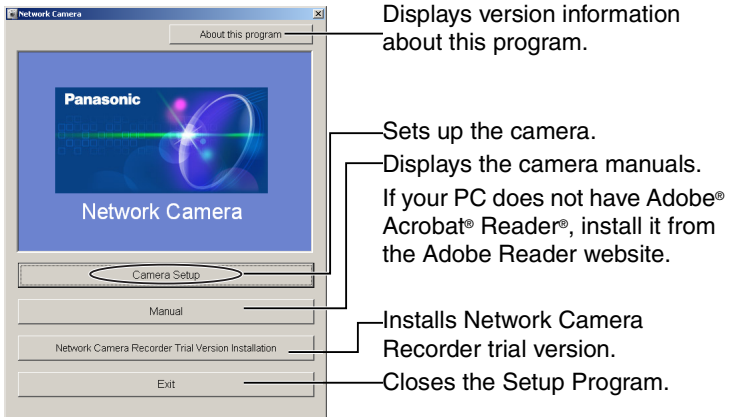



## Automatic Setup (Local or Internet Access) or Manual Setup

1. Click [Execute] on the Camera List window shown on page 143.
2. Click each button to execute the program.

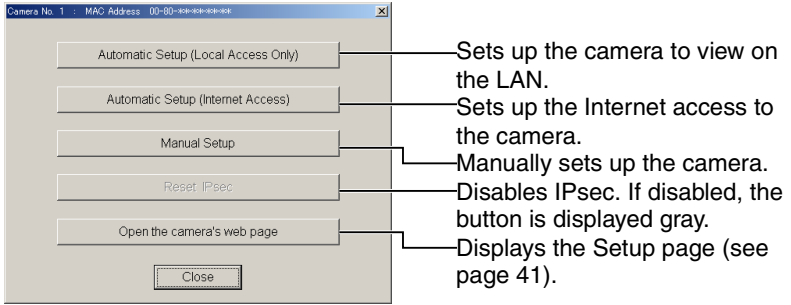

### Note

- For the first time installation or after pressing the FACTORY DEFAULT RESET button, you must select [Automatic Setup (Local Access Only)]. To start the Manual Setup, execute Automatic Setup (Local Access Only) first, and then start the Setup Program to execute the Manual Setup.
- See the Installation/Troubleshooting for the local and Internet access setup.

### Manual Setup window

Set up each parameter seeing page 46—page 48.

- If more than 20 minutes have passed since the camera was turned on, the camera cannot be set up from the Setup Program. If the camera cannot be set up, restart the camera.

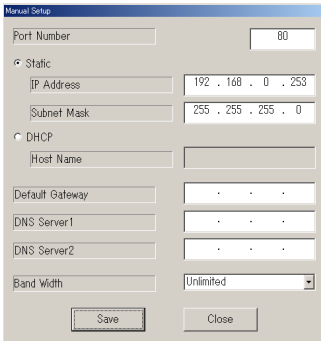



- If "Camera setup completed" is displayed, click [Close] to finish the Manual Setup.

**3.** Close all Setup windows.

## 3.9 Setting Your PC

### 3.9.1 Setting the Proxy Server Settings on Web Browser

If the proxy server is not used, the settings are not required. If you are using the proxy server, the following settings are required.

- To communicate with a camera installed inside a LAN, changing the web browser settings is recommended.
- A firewall of a proxy server in a corporate environment may prevent access to the camera. Consult your network administrator.

#### Note

- A proxy server is used to protect your network connected to the Internet.
- If the camera is accessed via a proxy server, problems may occur. Consult your network administrator before installing the camera.
- If the camera is accessed via a proxy server, the refresh interval may be slow.

### How to Set the Proxy Server Settings

1. Start up Internet Explorer. (The example is Internet Explorer 6.0.)
2. Click [Tools]→[Internet Options...].

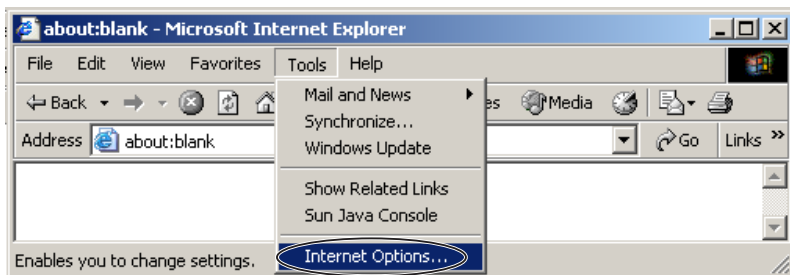

3. Click the [Connections] tab, and click [LAN Settings].

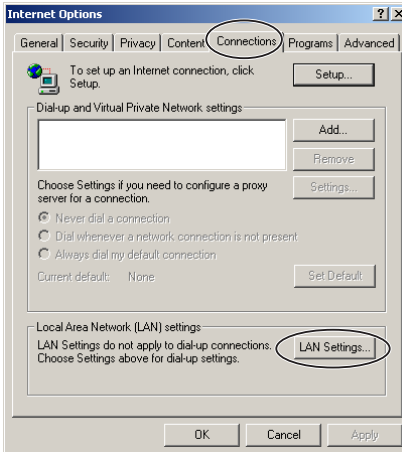

4. See if the Use a proxy server check box is checked or not. If checked, click [Advanced...].

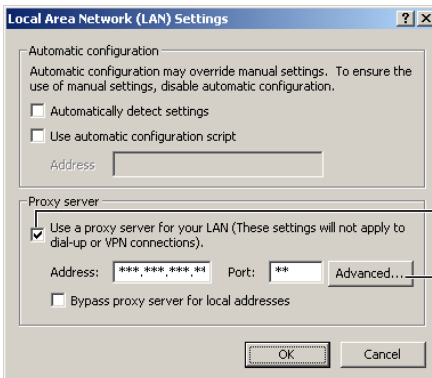

See if the check box is checked or not. If checked, click [Advanced...].

- If not checked, click [Cancel]. Proxy settings are not required.

5. Enter the camera IP address into the Do not use proxy server for addresses beginning with data field.

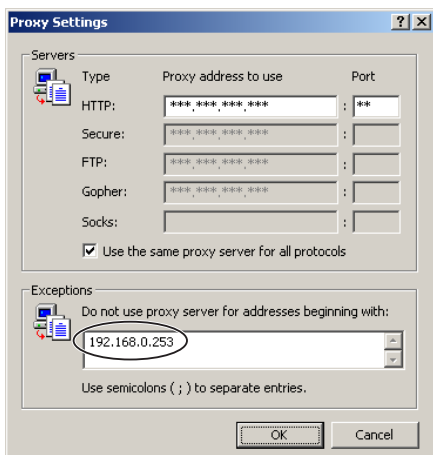

6. Click [OK].

**Note**

- When accessing the camera via a proxy server, the Talk Button is displayed gray. Talk feature cannot be used.

## 3.9.2 Setting UPnP™ to Display Camera Shortcut in My Network Places

To display the camera shortcut in the My Network Places folder, Windows component should be added. Enable UPnP™ (Universal Plug and Play) following the steps below.

OS	Steps
Windows XP	[Start] (→[Settings])→[Control Panel]→[Programs]→[Windows Components]→Select [Network Service]→[Properties]→Check [UPnP]→[OK]→[Next]→Complete
Windows XP Service Pack 2	[Start] (→[Settings])→[Control Panel]→[Programs]→[Windows Components]→Select [Network Service]→[Details...]→Check [Internet Gateway Device Discovery and Control Client]→Check [UPnP User Interface]→[OK]→Complete
Windows Me	[Start]→[Settings]→[Control Panel]→[Application]→[Windows File] tab→Select [Communication]→[Detail]→Check [UPnP]→[OK]→[OK]→[Restart]→Complete

### Note

This feature is available only when Windows XP or Windows Me is being used.

## 3.9.3 Setting the Internet Temporary File Setting on Web Browser

The old image may be displayed. In this case, set the web browser following the steps below.

[Tools]→[Internet Options]→[General] tab→[Settings] in the Temporary Internet files→Check [Every visit to the page] in the Check for newer versions of stored pages→[OK]→[OK]→Complete
--

### 3.10 ASCII Character Table

ASCII Character Table					
(space)	0	@	P	`	p
!	1	A	Q	a	q
"	2	B	R	b	r
#	3	C	S	c	s
\$	4	D	T	d	t
%	5	E	U	e	u
&	6	F	V	f	v
'	7	G	W	g	w
(	8	H	X	h	x
)	9	I	Y	i	y
*	:	J	Z	j	z
+	;	K	[	k	{
,	<	L	\	l	
-	=	M	]	m	}
.	>	N	^	n	~
/	?	O	_	o	

### 3.11 File Size and Number of Buffered Images

The following table shows the relationship between the file size of the image and the maximum number of buffered images.

#### **Note**

The following file sizes were shown at the largest value.

<b>Resolution</b>	<b>Items</b>	<b>Capture</b>	<b>Favor Clarity</b>	<b>Standard</b>	<b>Favor Motion</b>	<b>Mobile Phone</b>
640 x 480 (pixels)	File Size	About 60 KB	About 50 KB	About 33 KB	About 20 KB	-
	Buffered Images	-	About 40	About 60	About 100	-
320 x 240 (pixels)	File Size	About 30 KB	About 25 KB	About 16 KB	About 8 KB	About 8 KB
	Buffered Images	-	About 80	About 125	About 250	About 250
160 x 120 (pixels)	File Size	About 10 KB	About 7 KB	About 5 KB	About 3 KB	About 3 KB
	Buffered Images	-	About 290	About 400	About 675	About 675

## 3.12 Number of Images on the SD Memory Card

The camera supports the Panasonic SD memory card.

- 1 GB: RP-SDH01GU1A
- 512 MB: RP-SDH512U1A
- 256 MB: RP-SD256U1A
- 128 MB: RP-SD128BU1A
- 64 MB: RP-SD064BPPA

Resolution/ Image Quality		1 GB	512 MB	256 MB	128 MB	64 MB
160 x 120 (pixels)	Favor Motion	About 300,000	About 157,000	About 78,000	About 39,000	About 19,000
	Standard	About 180,000	About 94,000	About 47,000	About 23,000	About 11,000
	Favor Clarity	About 130,000	About 67,000	About 33,000	About 16,000	About 8,000
320 x 240 (pixels)	Favor Motion	About 110,000	About 58,000	About 29,000	About 14,000	About 7,000
	Standard	About 58,000	About 29,000	About 14,000	About 7,000	About 3,000
	Favor Clarity	About 37,000	About 18,000	About 9,000	About 4,000	About 2,000
640 x 480 (pixels)	Favor Motion	About 47,000	About 23,000	About 11,000	About 5,000	About 2,000
	Standard	About 28,000	About 14,000	About 7,000	About 3,000	About 1,000
	Favor Clarity	About 18,000	About 9,000	About 4,000	About 2,000	About 1,000



## 3.13 Specifications

### Network Camera

Items	Specifications
Zoom	12 steps, 42x (21x Optical Zoom, 2x Digital Zoom)
Pan/Tilt Angle	Pan: -175° to +175°, Tilt: -120° to 0° (On the table)/ 0° to +90° (On the ceiling)
Sensor Type	1/4-inch CCD (Interlace type), 380,000 pixels (Effective Pixels)
Illumination	3—100,000 lx (0.09—100,000 lx when in color night view mode)
White Balance	Auto/Manual/Hold
Focus	Auto/Manual (40 steps)
Minimum Object Distance	Wide: 5 mm (0.2 inches) Tele: 1 m (40 inches)
Caliber Ratio (F No.)	Tele: F1.6—Wide: F3.6
Horizontal Viewing Angle	Tele: 2.6° (Optical)/1.3° (Digital), Wide: 51°
Exposure	Auto

### Other Specifications

Items	Specifications
Video Compression	JPEG (3 Levels)
Video Resolution	640 x 480, 320 x 240 (default), 160 x 120
Buffered Image <sup>1</sup>	About 125 frames (320 x 240) with time display (SD memory card is not inserted.)
Audio Communication	2-way Half Duplex
Audio Bandwidth	300 Hz—3.4 KHz
Audio Play Method	Play with ActiveX
Input Encoding Method	Encoding with ActiveX

## Other Specifications

Items	Specifications
Audio Input <sup>2</sup>	3.5 mm Mini Jack
Audio Output <sup>2</sup>	3.5 mm Stereo Mini Jack (output is mono), Line Level
Video Output <sup>2</sup>	Analog Composite (NTSC)
Frame rate <sup>3</sup>	Max. 12 frames/second (640 x 480) Max. 30 frames/second (320 x 240 or 160 x 120)
Supported Protocols	IPv4/IPv6 Dual-Stack <ul style="list-style-type: none"> <li>• IPv4: TCP, UDP, IP, HTTP, FTP, SMTP, DHCP, DNS, ARP, ICMP, POP3, NTP, IPsec, UPnP</li> <li>• IPv6: TCP, UDP, IP, HTTP, FTP, SMTP, DNS, ICMPv6, POP3, NDP, NTP, IPsec</li> </ul>
IPsec Feature	ESP Encryption, ESP Authentication Transport mode/Tunnel mode IKE (Internet Key Exchange)
IKE (Internet Key Exchange)	Pre-Shared Key
Cipher Algorithm	DES-CBC, 3DES-CBC, AES-CBC
Message-Digest Algorithm	HMAC-MD5, HMAC-SHA-1
Message Transfer Condition	Alarm or Timer
Image Transfer Method	SMTP, FTP
Interface	10Base-T/100Base-TX Ethernet RJ-45 connector x 1
Indicator Display	Power/Network Communication/Camera operation/ Ethernet link
External I/O	External Sensor Input x 2 External Sensor Output x 1
SD Memory Card Slot	Full Size
Dimension (HWD)	140 mm (5.51 inches) x 123 mm (4.84 inches) x 123 mm (4.84 inches)

## Other Specifications

Items	Specifications
Weight	640 g (1.41 lb.) (Only the unit)
Power Supply	AC adaptor: Input 120 V AC, 60 Hz Output 12 V DC, 1A Consumption: About 12 W
Temperature	Operation: 0 °C (+32 °F) to +40 °C (+104 °F) Storage: 0 °C (+32 °F) to +50 °C (+122 °F)
Humidity	Operation: 20 %—80 % (No Condensation) Storage: 20 %—80 % (No Condensation)
Setting Angle	Available between $\pm 15^\circ$ based on level line for mounting both on the table and on the ceiling.

- <sup>1</sup> The maximum number of frames changes depending on the image quality and what object you buffer.
- <sup>2</sup> Use only the included Audio/Video Cable when connecting an external microphone, speaker, or TV.
- <sup>3</sup> Frame rate may slow down depending on the network environment, the PC performance, the image quality, enabling IPsec, SD memory recording or what object you view.



# Index

## A

Abbreviations 5  
ActiveX Controls 18  
Administrator/General Users/Guest Users 79  
Alarm Image Buffer/Transfer 100  
Alarm Position 28  
ASCII Character Table 150  
Audio page 75  
Automatic Focus Range 70

## B

Buffered Image page 36

## C

Camera Access 13  
Camera page 69  
Capture Image Button 22  
Cell Phone 39  
Cleaning 140  
Click to Center 21  
Confirming the Internet access 66  
CPU 6, 7

## D

Date and Time page 67  
Default Setting List 131

## E

Explanation of the External I/O 128  
External I/O 128  
External Output page 115

## F

FACTORY DEFAULT RESET Button 130  
Focus 26  
For IPv4 Connection 6  
For IPv6 Connection 7

## G

General User page 81

## H

Help page 126  
Home Position 28  
How to Use This Documentation 5

## I

Image Display page 84  
Indicator Control page 116  
IPsec 53  
IPv6 Domain Name Service 15

## L

Listen 32  
Load Settings page 124  
Login 80

## M

Maintenance page 117  
Multi-Camera page 34  
Multi-Camera Setup page 87

## N

Network (IPv4) page 44  
Network (IPv6) page 49

## O

Operating System 6, 7  
Operation Bar 23  
Operation Time page 113

## P

Pan/Tilt Range 24, 73  
Preset Button 28  
Product Information page 126  
Protocol 6, 7

## R

Reset to Factory Default page 125  
Restart page 119

**S**

Save Settings page 123  
SD memory card 89, 90  
Security: Administrator page 77  
Setup page 41  
Setup Program 142  
Single Camera page 17  
Specifications 153  
Status page 118  
Support Information page 127  
Support page 126  
System Requirements for your PC 6

**T**

Talk 32  
Timer Image Buffer/Transfer 91  
Top page 14  
Trademarks 5  
Transport mode 56, 111  
Tunnel mode 59, 112

**U**

Update Firmware page 120  
UPnP page 63

**V**

Vertical Resolution 72  
Viewnetcam.com Service 65

**W**

Web Browser 6, 7

**Z**

Zooming In and Out 25

### For product service

- Panasonic Servicenters are listed in the servicer directory.
- Call 1-800-272-7033 for the location of an authorized servicer.
- This Network Camera is designed for use in the United States of America. Sale or use of this product in other countries/areas may violate local laws.

### When you ship the product

- Carefully pack your unit, preferably in the original carton.
- Attach a letter, detailing the symptom, to the outside of the carton.

Symptom \_\_\_\_\_

- Send the unit to an authorized servicer, prepaid and adequately insured.
- Do not send your unit to the Panasonic Consumer Electronics Company listed below or to executive or regional sales offices. These locations do not repair consumer products.

The information in this document is subject to change without notice.

#### **Panasonic Consumer Electronics Company, Division of Panasonic Corporation of North America**

One Panasonic Way, Secaucus, New Jersey 07094

#### **Panasonic Puerto Rico, Inc.**

Ave. 65 de Infantería, Km. 9.5, San Gabriel Industrial Park  
Carolina, Puerto Rico 00985

#### **Copyright:**

This material is copyrighted by Panasonic Communications Co., Ltd., and may be reproduced for internal use only. All other reproduction, in whole or in part, is prohibited without the written consent of Panasonic Communications Co., Ltd.

© 2004 Panasonic Communications Co., Ltd. All Rights Reserved.